

87 Target

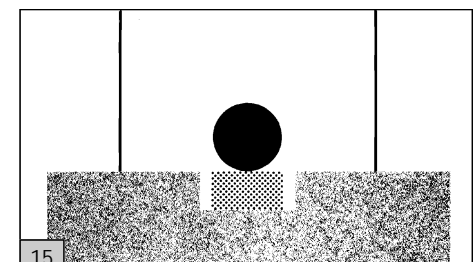

**Manuale di Istruzione
Instruction Manual
Mode d'Emploi**

 BERETTA



Le illustrazioni e descrizioni di questo opuscolo si intendono fornite a titolo indicativo. La Casa si riserva pertanto il diritto di apportare ai suoi modelli, in qualsiasi momento e senza preavviso, quelle modifiche che ritenesse utili per migliorarli o per qualsiasi esigenza di carattere costruttivo e commerciale.

The illustrations and descriptions given in this brochure are intended as a general guide only, and must not be taken as binding. The Company, therefore, reserves the right to make, at any moment and without notice, any changes it thinks necessary to improve its models or to meet any requirements of manufacturing or commercial nature.

Les illustrations et les descriptions contenues dans ce prospectus ne sont données qu'à titre indicatif. La Maison se réserve le droit de modifier, à tout moment et sans préavis, ses modèles pour les améliorer ou pour n'importe quelle exigence de caractère constructif et commercial.

Illustrations on pages 3, 10 and 18

NOTICE: The Manufacturer and/or its Local Official Distributors assume no responsibility for product malfunction or for physical injury or property damage resulting in whole or in part from criminal or negligent use of the product, improper or careless handling, unauthorized modifications, use of defective, improper, hand-loaded, reloaded or remanufactured ammunition, customer abuse or neglect of the product, or other influences beyond manufacturer's direct and immediate control.

WARNING: Always ensure that the safety is fully engaged until ready to fire. A safety is fully engaged only when the safety cannot move further into the safe position. A safety which is not fully engaged will not prevent firearm discharge.

WARNING: ALL FIREARMS HAVE LETHAL POTENTIAL. READ THE BASIC SAFETY RULES CAREFULLY AND UNDERSTAND THEM FULLY BEFORE ATTEMPTING TO USE THIS FIREARM.

In addition to the Basic Safety Rules, there are other Safety Rules pertaining to the loading, unloading, disassembly, assembly and use of this firearm located throughout this manual.

WARNING: READ THE ENTIRE MANUAL CAREFULLY BEFORE USING THIS FIREARM. MAKE SURE THAT ANY PERSON USING OR HAVING ACCESS TO THIS FIREARM READS AND UNDERSTANDS ALL OF THIS MANUAL PRIOR TO USE OR ACCESS.

	Page
BASIC SAFETY RULES	6
DESCRIPTION	11
GENERAL OPERATION	
TECHNICAL DATA	12
LOADING AND FIRING	12
LOADING THE MAGAZINE	
LOADING THE PISTOL AND THE CARTRIDGE CHAMBER	
FIRING	
UNLOADING THE PISTOL AND THE CARTRIDGE CHAMBER	
UNLOADING THE MAGAZINE	
ADJUSTING THE REAR SIGHT AND REPLACING THE FRONT SIGHT	
MAINTENANCE	15
FIELD STRIPPING	
CLEANING AND LUBRICATION	
ASSEMBLY	
MALFUNCTIONS, CAUSES AND REMEDIES	17

BASIC SAFETY RULES

1. NEVER POINT A FIREARM AT SOMETHING THAT IS NOT SAFE TO SHOOT.

Never let the muzzle of a firearm point at any part of your body or at another person. This is especially important when loading or unloading the firearm. When you are shooting at a target, know what is behind it. Some bullets can travel over a mile. If you miss your target or if the bullet penetrates the target, it is your responsibility to ensure that the shot does not cause unintended injury or damage.

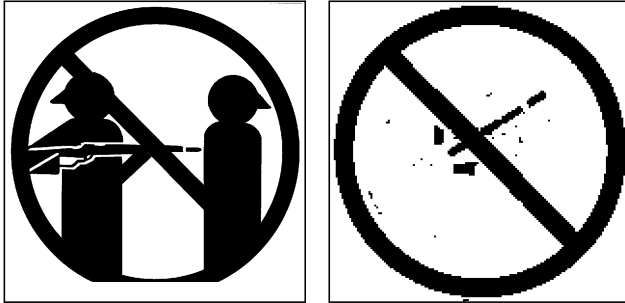

2. ALWAYS TREAT A FIREARM AS IF IT WERE LOADED.

Never assume that a firearm is unloaded. **The only certain way to ensure that a firearm is empty is to open the chamber and visually examine the inside to see if a round is present. Removing the magazine will not guarantee that a pistol is unloaded or cannot fire.** Shotguns and rifles can be checked by cycling or removing all rounds and by then opening the chamber so that a visual inspection of the chamber for any remaining rounds can be made.

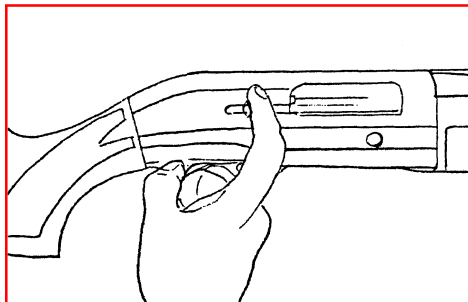
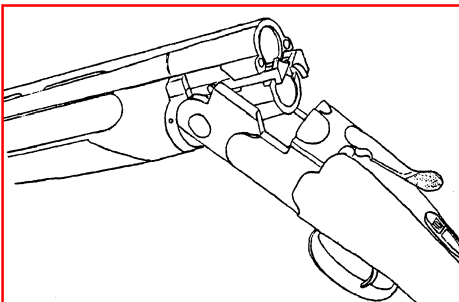
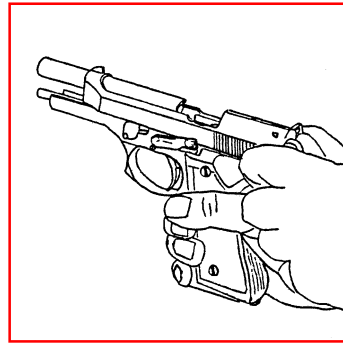

3. STORE YOUR FIREARM SO THAT CHILDREN CANNOT GAIN ACCESS TO IT.

It is your responsibility to insure that children under the age of 18 or other unauthorized persons do not gain access to your firearm. **To reduce the risk of accidents involving children, unload your firearm, lock it and store the ammunition in a separate locked location.** Please note that devices intended to prevent accidents - for example, cable locks, chamber plugs, etc. - may not prevent use or misuse of your firearm by a determined person. Steel gun safes may be more appropriate to reduce the likelihood of intentional misuse of a firearm by an unauthorized child or person.

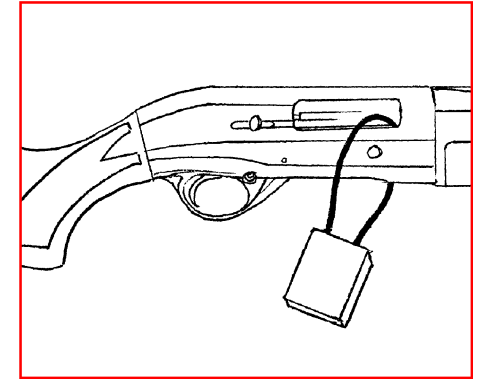
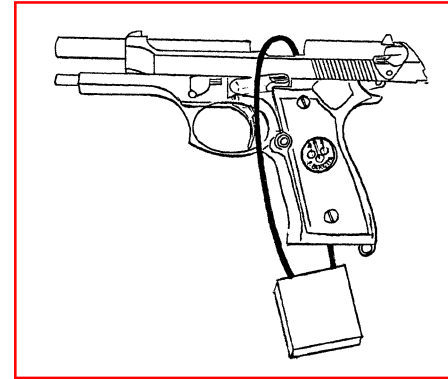

4. NEVER SHOOT AT WATER OR AT A HARD SURFACE.

Shooting at the surface of water or at a rock or other hard surface increases the chance of ricochets or fragmentation of the bullet or shot, which can result in the projectile striking an unintended or peripheral target.

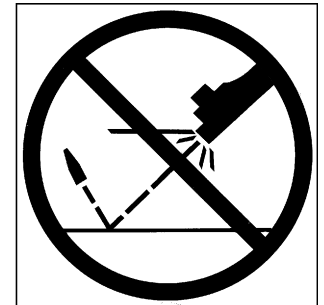

5. KNOW THE SAFETY FEATURES OF THE FIREARM YOU ARE USING, BUT REMEMBER: SAFETY DEVICES ARE NOT A SUBSTITUTE FOR SAFE HANDLING PROCEDURES.

Never rely solely on a safety device to prevent an accident. It is imperative that you know and use the safety features of the particular firearm you are handling, but accidents can best be prevented by following the safe handling procedures described in these safety rules and elsewhere in the product manual. To further familiarize yourself with the proper use of this or other firearms, take a Firearms Safety Course taught by an expert in firearms use and safety procedures.

6. PROPERLY MAINTAIN YOUR FIREARM.

Store and carry your firearm so that dirt or lint does not accumulate in the working parts. Clean and oil your firearm, following the instructions provided in this manual, after each use to prevent corrosion, damage to the barrel or accumulation of impurities which can prevent use of the gun in an emergency. Always check the barrel prior to loading to ensure that it is clean and free from obstructions. **Firing against an obstruction can rupture the barrel and injure yourself or others nearby.** In case you hear an unusual noise when shooting, stop firing immediately, engage the manual safety and unload the firearm. Make sure the chamber is free from any obstruction or possible bullet blocked inside the barrel due to defective or improper ammunition.



7. USE PROPER AMMUNITION.

Only use factory-loaded, new ammunition manufactured to industry specifications: CIP (Europe and elsewhere), SAAMI (U.S.A.). Be certain that each round you use is in the proper caliber or gauge and type for the particular firearm. The caliber or gauge of the firearm is clearly marked on the barrels of shotguns and on the slide or barrel of pistols. The use of reloaded or remanufactured ammunition can increase the likelihood of excessive cartridge pressures, casehead ruptures or other defects in the ammunition which can cause damage to your firearm and injury to yourself or others nearby.

8. ALWAYS WEAR PROTECTIVE GLASSES AND EARPLUGS WHEN SHOOTING.

The chance that gas, gunpowder or metal fragments will blow back and injure a shooter who is firing a gun is rare, but the injury that can be sustained in such circumstances is severe, including the possible loss of eyesight. A shooter must always wear impact resistant shooting glasses when firing any firearm. Earplugs help reduce the chance of hearing damage from shooting.



9. NEVER CLIMB A TREE, FENCE OR OBSTRUCTION WITH A LOADED FIREARM.

Open and empty the chamber of your firearm before climbing or descending a tree or before climbing a fence or jumping over a ditch or obstruction. Never pull or push a loaded firearm toward yourself or another person.



10. AVOID ALCOHOLIC BEVERAGES OR JUDGMENT OR REFLEX IMPAIRING MEDICATION WHEN SHOOTING.

Do not drink and shoot. If you take medication that can impair motor reactions or judgment, do not handle a firearm while you are under the influence of the medication.



11. NEVER TRANSPORT A LOADED FIREARM.

Unload a firearm before putting it in a vehicle. Hunters and target shooters should load their firearm only at their destination. If you carry a firearm for self-protection, leaving the chamber unloaded can reduce the chance of accidental discharge.

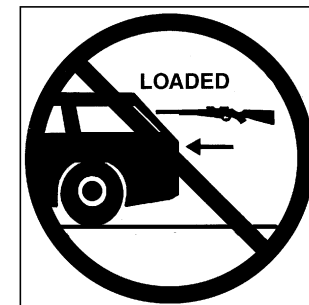

12. LEAD WARNING.

Discharging firearms in poorly ventilated areas, cleaning firearms, or handling ammunition may result in exposure to lead and other substances known to cause birth defects, reproductive harm, and other serious physical injury. Have adequate ventilation at all times. Wash hands thoroughly after exposure.

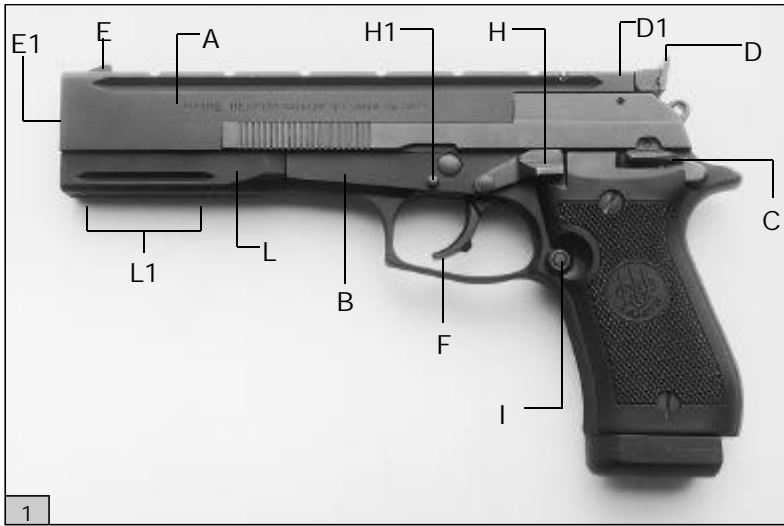

Safety engaged



with hammer lowered



with hammer in half-cock position



with hammer cocked

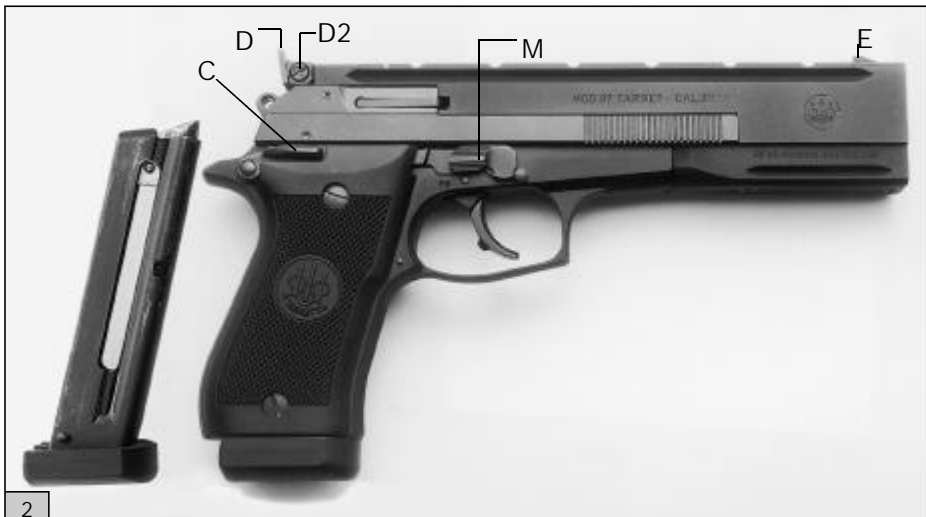

DESCRIPTION

The new Beretta 87 Target, caliber .22L.R., is designed for both competition shooting and range training.

The major characteristics are:

A. BARREL SLEEVE Fig. 1

It is designed to accept scope mounts.

B. FRAME MADE FROM A ZIRCONIUM-ALUMINUM ALLOY Fig. 1

The zirconium-aluminum alloy, specially treated, has the strength and durability of steel with 65% less weight.

C. AMBIDEXTROUS SAFETY LEVER Fig. 1-2

It is positioned on both sides of the pistol to allow easy and quick handling by right and left-handed shooters.

D. FULLY ADJUSTABLE TARGET SIGHT Fig. 1-2

E. INTERCHANGEABLE FRONT SIGHT Fig. 1-2

It is interchangeable with another front sight of different thickness. The resulting sight radius is 185 mm (7.28 in.) long.

F. TRIGGER PULL Fig. 1

The light and crisp trigger pull is factory set.

G. FINISHING Fig. 1-2

The matte-black finish is obtained through sand blasting and anodizing of the light aluminum alloy parts or bluing of the steel components.

GENERAL OPERATION

The Beretta 87 Target pistol is a semiautomatic firearm of the blow-back type. Upon firing, the pressure developed by the combustion gases recoils the slide which, during its rearward movement, extracts and ejects the fired cartridge case, cocks the hammer and activates the recoil spring. The slide will then automatically move forward towards the closed position, feeding the next cartridge from the magazine into the chamber.

The slide is designed to stay open after the last round has been fired and ejected.

TECHNICAL DATA

	87 Target
Caliber	.22L.R.
Operation	Semi-automatic, blow-back
Hammer	Exposed, single action
Length	225 mm. (8.9 in.)
Height	138 mm. (5.4 in.)
Weight (approx.)	835 gr. (29.4 oz.) (with empty magazine)
Barrel length	150 mm. (5.9 in.)
Rifling	R.H., 6 grooves (pitch 350 mm.) - (13.8 in.)
Front sight	Blade, interchangeable (2 sizes)
Rear sight	V notch, adjustable for elevation and windage
Sight radius	185 mm. (7.28 in.)
Safeties	Ambidextrous manual thumb safety; it locks the sear and the slide in the closed position
Magazine	Straight-line, 10 rounds
Frame	Light alloy, sand blasted and anodized
Slide	Steel, blued
Barrel	Steel, blued
Barrel sleeve	Aluminum, sand blasted and anodized
Special features	Barrel sleeve with integral scope base

NOTICE: The figure numbers noted below refer to the photographs on pages 3, 24 and 46.

LOADING AND FIRING

WARNING: Before loading the firearm, practice the following loading procedures without the use of ammunition. Never handle a loaded firearm until you are fully familiar with the loading procedures. Always point the firearm in a safe direction. (See points 1, 2 and 4 of the BASIC SAFETY RULES).

WARNING: Always keep your finger away from the trigger whenever you do not intend to fire. Make sure the pistol is not already loaded. Remove the magazine from the pistol by depressing the magazine release button (fig. 6). Keeping your finger away from the trigger, grasp the slide serrations with thumb and index fingers and retract the slide 2 centimeters (approx. one inch) to verify that the chamber is empty (fig. 7).

WARNING: When sure that the chamber is empty, point the firearm in a safe direction and holding hammer spur with thumb, completely press trigger and lower the hammer slowly forward to the uncocked position.

LOADING THE MAGAZINE

- Hold magazine in left hand. With right hand, place a cartridge on the follower in front of the lips, press down and slide the cartridge back under the magazine lips (fig. 8). Repeat until the magazine is fully loaded. Side slots allow visual counting of cartridges (maximum 10).

LOADING THE PISTOL AND THE CARTRIDGE CHAMBER

WARNING: Always keep your finger away from the trigger whenever you do not intend to fire.

- Push loaded magazine into pistol grip completely to insure catch engagement.
- Grasping the slide serrations with thumb and forefinger, fully retract and quickly release the slide to load the chamber (fig. 9).

WARNING: THE PISTOL IS NOW LOADED, COCKED AND READY TO FIRE. Always keep fingers away from the trigger, whenever you do not intend to fire.

Engage the manual safety by simply rotating the safety lever (C) completely upwards using your thumb (fig. 10). The red warning dot will disappear (fig. 5) (the red warning dot can be seen only when the manual safety is disengaged).

NOTICE: The manufacturer assumes no responsibility for any injury or property damage resulting from improper or careless handling, intentional or accidental discharge of the firearm.

WARNING: The Beretta 87 Target is a target pistol and therefore it **is not equipped** with a safety hammer decocking device. For this reason **never try to lower the hammer** with a round in the chamber.

FIRING

WARNING: Always wear protective glasses and earplugs when shooting (see point 8 of the BASIC SAFETY RULES).

WHEN READY TO FIRE

- Release the manual safety by simply rotating the safety lever (C) completely downwards using your thumb. The red warning dot can be seen when manual safety is disengaged.
- Aim pistol and align front and rear sight on target (fig. 15).
- Fire by squeezing the trigger.

The discharge will recoil the slide which, in turn, will extract and eject the fired cartridge case, cock the hammer and activate the recoil spring. Then the slide will automatically close, feeding the next cartridge from the magazine into the chamber and the PISTOL IS READY TO FIRE AGAIN.

- When the last round has been fired, the slide remains open (fig. 11).
- To fire again, remove the empty magazine and insert a loaded one.
- Press slide catch (H) to close the slide and load the chamber (fig. 12).

WARNING: THE PISTOL IS NOW LOADED, COCKED AND READY TO FIRE AGAIN. ENGAGE THE MANUAL SAFETY IF NOT READY TO FIRE.

WARNING: The Beretta 87 Target is a target pistol and therefore it is **not equipped** with a safety hammer decocking device. For this reason **never try to lower the hammer** with a round in the chamber.

To have the pistol in a safety condition, **it is necessary to unload it**. Proceed as indicated in the following chapter.

UNLOADING THE PISTOL AND THE CARTRIDGE CHAMBER

WARNING: Keep fingers away from the trigger.

- ▮ Engage the manual safety if not already engaged.
- ▮ Depress magazine release button (I) to remove the magazine.
- ▮ Point pistol in a safe direction and release manual safety.
- ▮ Grasping the slide serrations with thumb and forefinger, fully retract the slide to eject chambered round (fig. 13).

WHEN SURE THAT THE CHAMBER IS EMPTY AND THE CARTRIDGE HAS BEEN EJECTED, quickly release the slide.

WARNING: Point the firearm in a safe direction and holding hammer spur with thumb, completely press trigger and lower the hammer slowly forward to the uncocked position.

UNLOADING THE MAGAZINE

- ▮ To unload magazine, hold it upright with front end forward. With the tip of the thumb firmly press down on the cartridge rim and push towards the front of magazine box. As the cartridge moves forward, tip it slightly upwards with forefinger (fig. 14).
- ▮ Repeat until magazine is empty.

ADJUSTING THE REAR SIGHT AND REPLACING THE FRONT SIGHT

The rear sight of Beretta 87 Target pistol is factory adjusted aligning front and rear sight (D) on the mark as shown in fig. 15.

If necessary to modify the sight adjustment, proceed as follows:

ADJUSTMENT FOR ELEVATION (UP). To raise the point of impact on target, turn the upper screw (D1) counter-clockwise using a suitable screwdriver (follow the arrow marked on the sight). Proceed one sector (click of the screw) at a time so that the finest adjustment is obtained (fig. 16).

To lower the point of impact, turn the screw clockwise.

ADJUSTMENT FOR WINDAGE. To move the point of impact on target to the left, turn the side screw (D2) clockwise following the arrow marked on the right side of sight. Proceed one sector (click of the screw) at a time so that the finest

FRONT SIGHT REPLACEMENT

The pistol is supplied with 2 interchangeable front sights of the same height but of different thickness. The 2.5 mm front sight (E) is factory mounted and the 2 mm one is supplied separately.

To replace front sight use a 2 mm Allen key and remove, unscrewing counter-clockwise, the screw (E1) located over the muzzle. Extract front sight from its seat with an upward movement (fig. 18).

After replacing front sight, tighten the socket head screw without applying excessive force.

MAINTENANCE

Every time the pistol is fired, or at least once a month, cleaning and lubricating is recommended.

FIELD STRIPPING

WARNING: Make sure the pistol is unloaded. If not, unload it following the "UNLOADING THE PISTOL" procedure.

WARNING: It is recommended to wear protective glasses during the field stripping and assembly procedures.

NOTICE: It is advisable to carry out the field stripping and the assembly operations over a table to catch components should they drop.

- ▮ Remove magazine by depressing magazine release button.

NOTICE: Field stripping of Beretta 87 Target can be carried out only after the counterweight slide locking screws (L1) have been loosened and the counterweight slide (L) has been removed.

Proceed as follows:

- ▮ Unscrew the two counterweight slide locking screws (L1) using a 3 mm Allen key (fig. 19) and remove the counterweight slide (L).
- ▮ Hold pistol in the left hand, pressing with forefinger the disassembly latch release button (M1) (fig. 20); with right thumb rotate disassembly latch (M) counter-clockwise until it stops (fig. 21).
- ▮ Pull the barrel sleeve, slide, recoil spring and spring guide assembly forwards (fig. 22).
- ▮ Pressing recoil spring guide head (**caution:** the recoil spring is under compression) lift the recoil spring guide and let the spring expand slowly (fig. 23).
- ▮ Separate the slide from the barrel-barrel sleeve assembly.

CAUTION: No further disassembly is recommended unless done by a competent gunsmith.

CLEANING AND LUBRICATION

WARNING: Excess oil and grease obstructing the bore even partially are very dangerous when firing and may cause damage to the pistol and serious injury to the shooter and bystanders. Never spray or apply oil to the cartridges. Use lubricants properly: you are responsible for the proper care and maintenance of your firearm.

MAGAZINE

- Make sure the magazine is thoroughly clean and the follower slides easily downward if pressed.
- If necessary lightly oil (using Beretta or a good grade gun oil) the internal and external walls of the magazine box.
- Run a dry patch through the box. Do not leave lubricant inside the magazine box.
- If the pistol is carried with the magazine loaded, it is important to periodically unload all magazines for cartridge inspection.

BARREL

- Spray the brush supplied with gun oil. Insert it into the barrel from the chamber end and slide it backward and forward a few times.
- Dry the barrel by pushing a patch through with the brush supplied. Keep changing the patch until it emerges clean from the barrel.
- Lightly oil the inside and outside of the barrel, using a lightly oiled patch.
- Lightly oil guides of the barrel base.

SLIDE

- Clean slide with an oily patch paying special attention to breech face, to guide rails and to extractor housing; if necessary use the brush supplied.
- Lightly oil the slide with gun oil.

RECOIL SPRING AND SPRING GUIDE

- Lightly oil recoil spring and spring guide with gun oil. After long use it may be necessary first to clean with gun oil and then with the soft brush supplied.

CAUTION: Do not apply excess oil: accumulation of oil attracts dirt which can plug the barrel and interfere with the functioning and reliability of the pistol.

ASSEMBLY

WARNING: It is recommended to wear protective glasses during the field stripping and assembly procedures.

Assemble following the Field Stripping procedure in reverse order. Pay attention to the following points:

- The barrel should rest perfectly against the slide (the extractor must lodge in its

groove in the barrel).

- The recoil spring guide head should lodge in the center of its seat in the barrel base.
- When rotating disassembly latch, the slide should be in the closed position (aligned

NOTICE: Before screwing the counterweight slide locking screws (L1), make sure that the counterweight slide (L) is in correct position and then tighten the screws (L1) without applying excessive force.

WARNING: Do not store firearms in places which are or could be accessible by children or other persons whose unfamiliarity with firearms might lead to unsafe use. Always store your firearms securely and unloaded, separate from ammunition. (See point 3 of the BASIC SAFETY RULES).

MALFUNCTIONS, CAUSES AND REMEDIES

MALFUNCTION	PROBABLE CAUSE	REMEDY
Mis-introduction of a cartridge into the chamber	Defective cartridge	Inspect and replace cartridge
Mis-fire	Defective cartridge	Keep pistol muzzle in a safe direction and pull the trigger once more or replace cartridge
Mis-extraction or defective extraction	Dirty cartridge chamber	Clean and lubricate cartridge chamber
	Defective or dirty ammunition	Replace or clean cartridges
	Dirt under the extractor	Clean the extractor housing

CAUTION: No one should attempt to make recommended repairs without proper knowledge or training.

NOTICE: Wholesalers, dealers or gunsmiths (unless they are a Repair Station authorized by the Manufacturer and/or by its Local Official Distributors) are not authorized to make any Warranty repair or adjustment on behalf of the Manufacturer.



 BERETTA

Fabbrica d'Armi Pietro Beretta S.p.A.
Via Pietro Beretta, 18 - 25063 GARDONE VAL TROMPIA (Brescia) Italia
Tel. (030) 8341.1 - Telex 301523 PB BS I - Telefax (030) 8341.421
Internet: <http://www.beretta.it>