

# Beretta pistol



series **950**

**BERETTA**



**Mod. 950 BS Jet Fire  
with tilted barrel**

## **BERETTA 950 BS JET FIRE SEMI-AUTOMATIC PISTOL**

**CAUTION:** Read this manual carefully BEFORE loading the pistol.

### **INTRODUCTION:**

This single action only model is available in caliber .25 ACP with features rarely found in sporting pistols. It has the strength, precision, sturdiness and safety devices usually characteristic of pistols in larger caliber, weight and dimensions.

No physical strength is required in loading due to a unique barrel mounting system. By a simple movement of a lever, the barrel is released for direct chamber loading and immediate firing. Close the barrel, insert a loaded magazine, cock the hammer and you are ready to fire additional rounds.

Beretta's world famous reputation for making the finest product is maintained in manufacturing of the Series 950 BS Jet Fire in the United States.

The 950 BS Jet Fire pistol has an INERTIA type firing pin, assuring greater safety if necessary to carry the pistol chamber loaded (NOT RECOMMENDED).

The 950 BS Jet Fire pistol also employs a MANUAL THUMB SAFETY. The Safety can be engaged to its "ON" position by an upward flick of the thumb. It can be engaged with the hammer either fully-cocked or half-cocked. The Safety prevents accidental trigger pull. (See paragraph BASIC SAFETY.) When the Safety is disengaged "OFF" (down), a Red Warning Dot is visible.

The Frame is machined from a high strength aluminum alloy forging, and its surface is anodized finished.

The Barrel is machined from a special high grade barrel steel forging, and its surface is protected by a "deep durable" hot-blueing or highly polished nickel finish.

The Slide is machined from a high strength steel forging, and finished by the same process as the barrel.

The small parts are manufactured of special selected high quality steel and hardened according to each part's individual function. All parts are made to tight tolerances to insure the highest degree of interchangeability.

## Caution: Read this manual carefully before handling and loading the pistol.

**WARNING:** Always ensure that the safety is fully engaged until ready to fire. A safety is fully engaged only when the safety can move no further into the safe position. A safety which is not fully engaged will not prevent weapon discharge.

### BASIC SAFETY RULES

1. NEVER POINT A FIREARM AT SOMETHING THAT IS NOT SAFE TO SHOOT.

Never let the muzzle of a firearm point at any part of your body or at another person. This is especially important when loading or unloading the firearm. When you are shooting at a target, know what is behind it. Some bullets can travel over a mile. If

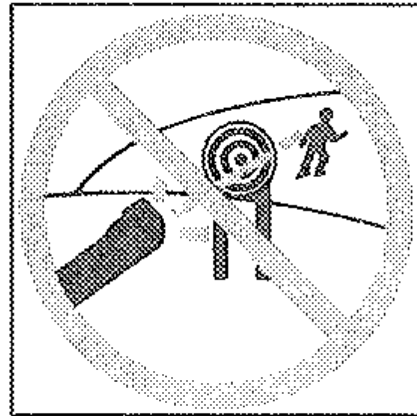
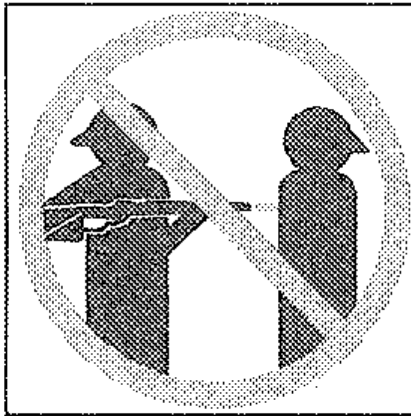

you miss your target or if the bullet penetrates the target, it is your responsibility to ensure that the shot does not cause unintended injury or damage.

2. ALWAYS TREAT A FIREARM AS IF IT WERE LOADED.

Never assume that a firearm is unloaded. **The only certain way to ensure that a firearm is empty is to open the chamber and visually examine the inside to see if a round is present. Removing the magazine will not guarantee that a pistol is unloaded or cannot fire.** Shotguns and rifles can be checked by cycling or removing all rounds and by then opening the chamber so that a visual inspection of the chamber for any remaining rounds can be made.

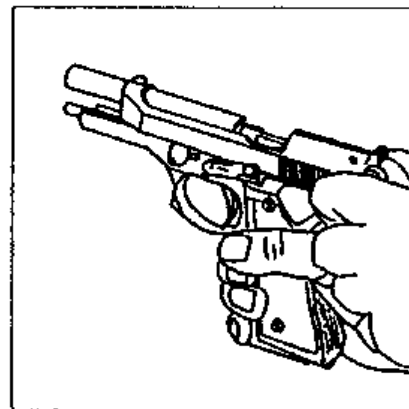

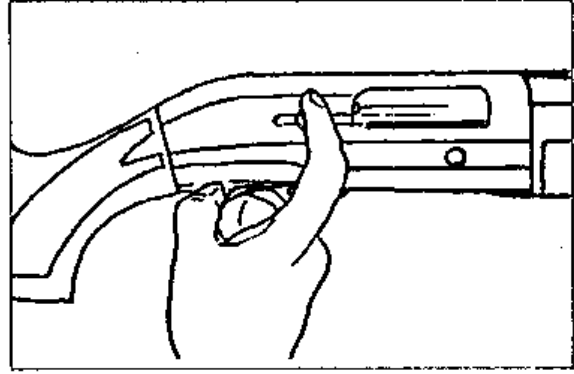
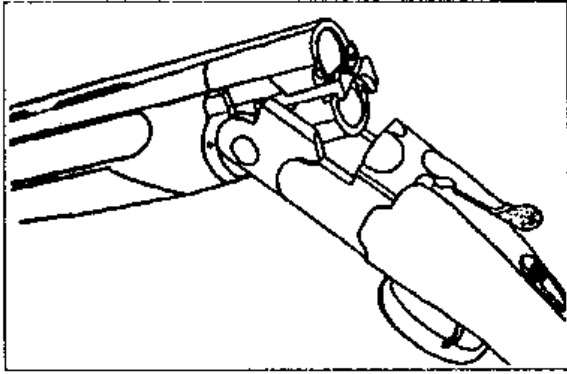

3. **STORE YOUR FIREARM SO THAT CHILDREN CANNOT GAIN ACCESS TO IT**  
It is your responsibility to insure that children under the age of 18 or other unauthorized persons do not gain access to your firearm. **To reduce the risk of accidents involving children, unload your firearm, lock it and store the ammunition in a separate locked location.** Please note that devices intended to prevent accidents—for example, cable locks, chamber plugs, etc.—may not prevent use or misuse of your firearm by a determined person. Steel gun safes may be more appropriate to reduce the likelihood of intentional misuse of a firearm by an unauthorized child or person.

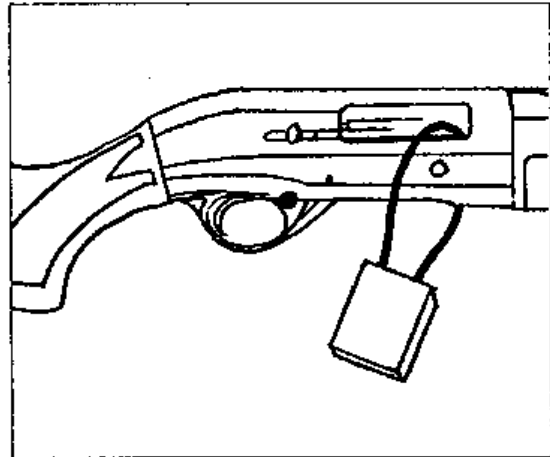
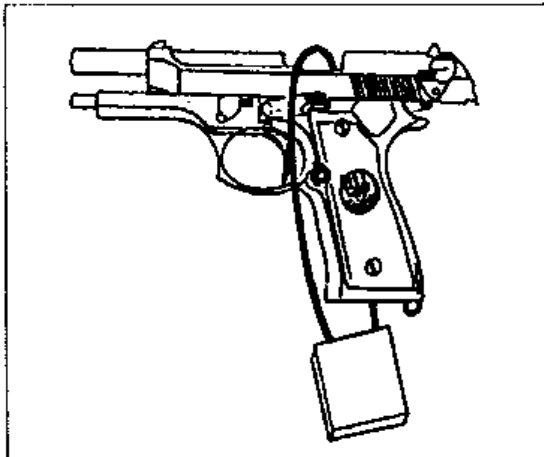

4. **NEVER SHOOT AT WATER OR AT A HARD SURFACE.**  
Shooting at the surface of water or at a rock or other hard surface increases the chance of ricochets or fragmentation of the bullet or shot, which can result in the projectile striking an unintended or peripheral target.

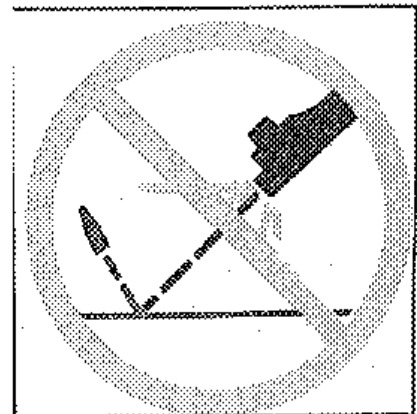

5. KNOW THE SAFETY FEATURES OF THE FIREARM YOU ARE USING, BUT REMEMBER: SAFETY DEVICES ARE NOT A SUBSTITUTE FOR SAFE HANDLING PROCEDURES.

Never rely solely on a safety device to prevent an accident. It is imperative that you know and use the safety features of the particular firearm you are handling, but accidents can best be prevented by following the safe handling procedures described in these safety rules and elsewhere in the product manual. To further familiarize yourself with the proper use of this or other firearms, take a Firearms Safety Course taught by an expert in firearms use and safety procedures.

6. PROPERLY MAINTAIN YOUR FIREARM.

Store and carry your firearm so that dirt or lint does not accumulate in the working parts. Clean and oil your firearm, following the instructions provided in this manual, after each use to prevent corrosion, damage to the barrel or accumulation of impurities which can prevent use of the gun in an emergency. Always check the barrel prior to loading to ensure that it is clean and free from obstructions. **Firing against an obstruction can rupture the barrel and injure yourself or others nearby.** In case you hear an unusual noise when shooting, stop firing immediately, engage the manual safety and unload the firearm. Make sure the chamber is free from any obstruction or possible bullet blocked inside the barrel due to defective or improper ammunition.

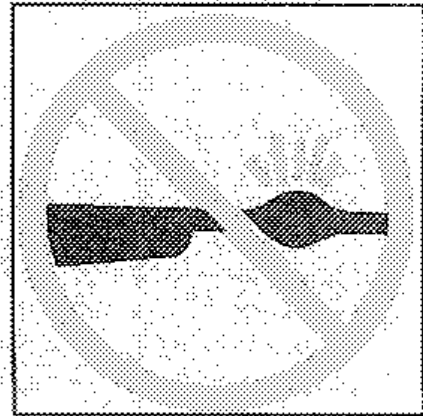

7. USE PROPER AMMUNITION.

Only use factory-loaded, new ammunition manufactured to industry specifications: CIP (Europe and elsewhere), SAAMI (U.S.A.). Be certain that each round you use is in the proper caliber or gauge and type for the particular firearm. The caliber or gauge of the firearm is clearly marked on the barrels of shotguns and on the slide or barrel of pistols. The use of reloaded or remanufactured ammunition can increase the likelihood of excessive cartridge pressures, casehead ruptures or other defects in the ammunition which can cause damage to your firearm and injury to yourself or others nearby.

8. ALWAYS WEAR PROTECTIVE GLASSES AND EARPLUGS WHEN SHOOTING.

The chance that gas, gunpowder or metal fragments will blow back and injure a shooter who is firing a gun is rare, but the injury that can be sustained in such circumstances is severe, including the possible loss of eyesight. A shooter must always wear impact resistant shooting glasses when firing any firearm. Earplugs help reduce the chance of hearing damage from shooting.



**9. NEVER CLIMB A TREE, FENCE OR OBSTRUCTION WITH A LOADED FIREARM.**

Open and empty the chamber of your firearm before climbing or descending a tree or before climbing a fence or jumping over a ditch or obstruction. Never pull or push a loaded firearm toward yourself or another person.



**10. AVOID ALCOHOLIC BEVERAGES OR JUDGMENT OR REFLEX IMPAIRING MEDICATION WHEN SHOOTING.**

Do not drink and shoot. If you take medication that can impair motor reactions or judgment, do not handle a firearm while you are under the influence or the medication.

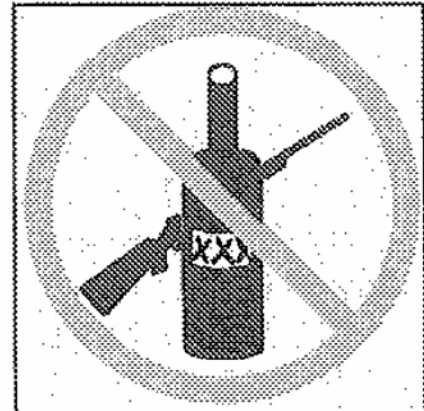

**11. NEVER TRANSPORT A LOADED FIREARM.**

Unload a firearm before putting it in a vehicle. Hunters and target shooters should load their firearm only at their destination. If you carry a firearm for self-protection, leaving the chamber unloaded can reduce the chance of accidental discharge.

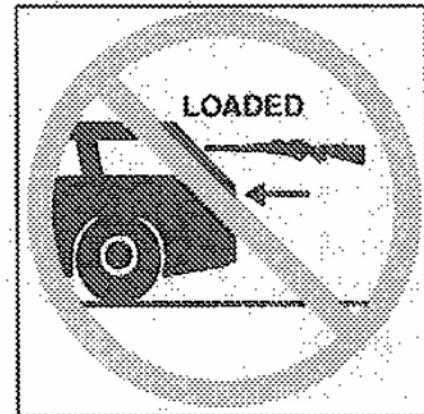

**12. LEAD WARNING.**

Discharging firearms in poorly ventilated areas, cleaning firearms or handling ammunition may result in exposure to lead and other substances known to cause birth defects, reproductive harm, and other serious physical injury. Have adequate ventilation at all times. Wash hands thoroughly after exposure.

**SAFE STORAGE OF PISTOL AND AMMUNITION:**

A loaded/unloaded pistol in an unlocked area is not safe from the curiosity seeker. If stored in an unlocked area, be SURE the pistol is unloaded and the ammunition is stored elsewhere.

To avoid corrosion during storage, the pistol should be thoroughly cleaned and all metal surfaces protected by a light film of a good grade of gun oil. Store pistol unwrapped in a container placed in a ventilated area.

Store ammunition in a container placed in a cool ventilated area.

### **AMMUNITION:**

Before leaving the factory the pistol has been: thoroughly inspected, proof load testfired for material strength and performance, and testfired with several rounds of standard factory loaded ammunition.

After "break in" shooting you may find that your pistol (like most other semi-auto pistols) shoots better with one or two brands of ammunition.

The Model 950 BS Jet Fire is chambered for caliber .25 Auto, also know as .25 ACP or 6.35mm Browning. Some older versions of the Model 950 are chambered for .22 short. The caliber of any given Model 950 is stamped on the pistol.

### **SAFE TRANSPORTATION:**

If local laws permit carrying your pistol in a vehicle, check that it is unloaded (empty chamber, magazine removed, and the hammer fully lowered).

IN THE FIELD (where legal), the pistol should be carried unloaded (empty chamber, magazine removed and hammer fully lowered) in a holster, with the magazine in a belt pouch or pocket. It takes only a second to insert the loaded magazine, and a fraction of a second to retract and release the slide for chamber loading and cocking; or, if preferred, to release the barrel for direct loading and hammer cocking, making the pistol ready to fire.

Remember—keep your finger OUTSIDE the trigger guard until ready to fire.

ON THE RANGE, the magazine should be removed and the barrel released until ready to fire. Never load the chamber until you are ready to fire.

NOTE: The situation could arise in shooting (field or range) when the chamber is loaded and you want to lock the cocked hammer to prevent inadvertent discharge. Here the THUMB or MANUAL Safety should be used.



Being careful of the muzzle direction, push the Safety fully into its upward position. Remember—the pistol is still cocked and loaded! As soon as possible UNLOAD the pistol.

Remember—The quick barrel release can always be used as a Safety device against accidental discharge. Flip the barrel release lever and, when the barrel springs to the tilted position, the pistol cannot be fired unless the barrel is returned to its downward locked position.

### **LOADING THE MAGAZINE:**

**CAUTION!!** Make sure the pistol is not already loaded:

To Remove The Magazine:

Depress the Magazine Release Button located on the left side's lower rear corner of pistol grip, and withdraw magazine.

To Load The Magazine:

Hold the magazine in the left hand. With your right hand place a cartridge on the follower in front of the lips, press down and slide the cartridge completely back under the lips. Repeat until the magazine is fully loaded. Holes on both sides of the magazine allow for visual counting of cartridges.

### **TO LOAD THE PISTOL BY THE BARREL TILTING METHOD:**

Release the Barrel by a forward movement of the Barrel Lever, which is conveniently located on the frame's left side above the trigger. Insert the cartridge into the chamber, and push the barrel down. A sharp click indicates Barrel Lever Engagement. The pistol is now chamber loaded and ready to fire.

Now push the fully loaded magazine into the grip's magazine well. A sharp click indicates magazine catch engagement. The pistol is chamber and magazine loaded and ready to fire.

### **TO LOAD THE PISTOL BY SLIDE MANIPULATION:**

Push the fully loaded magazine into the grip's magazine well. A sharp click indicates magazine catch engagement.

Grasp the slide serration with thumb and index finger (keep finger outside the trigger guard), retract the slide to solid stop (activating the recoil spring and cocking the hammer).

QUICKLY release the slide. The slide will automatically close—chambering the first cartridge from the magazine. The pistol is ready to fire.

### **SINGLE ACTION TRIGGER PULL:**

Remember—when the Hammer is fully lowered to rest against the slide, the pistol cannot be fired by trigger pull. The Safety cannot be engaged. By retracting the Hammer to its half-cock (hammer drop catch) position and engaging the Safety (upward turning—Red Warning Dot covered), the pistol cannot be fired. By retracting the Hammer to its fully-cocked position, the pistol is READY TO FIRE by trigger pull (Safety Disengaged—RED WARNING DOT VISUAL). Engaging the Safety secures the pistol against accidental discharge by trigger pull.

### **UNLOADING OF PISTOL AND MAGAZINE:**

If hammer is cocked, insure that the Safety is engaged. Release the barrel by a forward movement of the Barrel Lever, and remove the chambered cartridge.

NOTE: Quick barrel release may eject the chambered cartridge. If the barrel is released under finger support, the cartridge will remain in the chamber—elevate the muzzle and the cartridge will fall out.

Depress the Magazine Release Button and remove the magazine.

Disengage the Safety and fully lower the hammer.

To unload the Magazine, grasp with one hand around the magazine box, bottom down and front end forward. With the tip of the thumb firmly press down on the cartridge RIM and push—as the bullet moves forward, tip it slightly upward with the index finger. Repeat until unloaded.

Remember—to avoid malfunction always keep the magazine clean. Dropping the magazine may dent the box, and bend and/or burr the lips. With a suitable instrument depress the follower to check for free movement.

### **HOW TO LOWER THE HAMMER:**

WARNING!! Even though the Model 950 BS Jet Fire has an Inertia Firing Pin (reduces chances of accidental discharge), a falling hammer (even from a short

distance) may cause discharge, especially if the cartridge has a sensitive primer. We do not recommend lowering the hammer on a chambered round.

**NOTE:** The Model 950 BS Jet Fire has an added safeguard: The barrel can be released (tipped up) before lowering the hammer on a chambered round.

To Lower the fully-cocked Hammer to fully-lowered position:

Disengage the Safety. Manually retract the hammer spur. Depress the trigger while cautiously allowing the hammer to move all the way forward under thumb control.

**WARNING!!** If chamber loaded (not recommended), be extremely careful while depressing the trigger because the hammer will not be caught by the hammer's half-cock notch (hammer drop catch) if your finger slips off the spur.

To Place the Hammer in the Half-Cocked Position:

If the Hammer is fully-lowered, retract hammer until the sear snaps into the half-cock notch. (Keep Finger Off Trigger.)

If the Hammer is fully-cocked, disengage the Safety—manually retract the hammer spur—depress the trigger while CAUTIOUSLY allowing the hammer to move all the way forward under thumb control. Keep finger off trigger. Retract hammer until sear snaps into the half-cock notch.

### **SAFETY/FULLY-COCKED HAMMER RELATIONSHIP:**

Remember—if the pistol is chamber loaded by slide manipulation or automatically during the shooting cycle, or if the hammer is retracted by hand, the hammer is fully-cocked and the pistol is ready to fire.

**WARNING!!** Careless handling of a loaded pistol, with or without the safety engaged, could result in accidental discharge. DO NOT check the mechanical functioning of the Safety when the CHAMBER IS LOADED—check it with empty chamber. DO NOT try to override the Safety by asserting excessive trigger pull force.

A sharp click from a spring plunger can be heard when the Safety is turned between "ON" and "OFF." The spring plunger secures the Safety in either position.

The Safety is ENGAGED "ON" in its upward position. NO Warning Dot is visible.

The Safety is DISENGAGED "OFF" in its downward position. The RED WARNING DOT is visible.

The Safety, when engaged, securely blocks the Sear, preventing trigger pull and hammer fall.

The Safety, when engaged, locks the slide.

### **SAFETY/HALF-COCKED HAMMER RELATIONSHIP:**

To REDUCE the chance of untriggered discharge due to accidental hammer fall from the fully cocked position, the falling hammer is caught and secured in its half-cocked position by the sear entering the Hammer's Drop Catch Notch.

**DO NOT PULL THE TRIGGER WHEN THE HAMMER IS IN HALF-COCKED POSITION.**

Remember—the half-cocked position is an emergency (not a prime) Safety Device. The sear is firmly engaged to the hammer's drop catch notch when the hammer is half-cocked.

Because of this pistol's design, it requires very heavy trigger pull to release the hammer when half-cocked. Do not damage this excellent secondary emergency safety device by forceful trigger pull testing.

When the hammer is HALF-COCKED, the Manual Safety can be engaged. THE SAFETY PREVENTS TRIGGER PULL, and restricts hammer and slide manipulation.

**DO NOT PULL THE SLIDE AND COCK THE HAMMER WHEN THE HAMMER IS HALF-COCKED AND SAFETY ENGAGED.**

Remember—the Safety locks the Sear and prevents trigger pull. Since the trigger cannot be pulled, the hammer cannot be lowered. The Safety, by blocking the sear, also restricts the hammer from being hand manipulated to its full-cocked position; and, since the hammer cannot go all the way back, the slide movement is also restricted. A FORCEFUL attempt to fully-cock the hammer or pull the slide may damage the mechanism.

## **SAFETY/FULLY-LOWERED HAMMER RELATIONSHIP:**

The Safety CANNOT be engaged with the Hammer Fully-Lowered.

## **FIRING:**

Check that your target and backstop are safe.

Aim the pistol in a safe direction and release the Safety if engaged. Feed a round into the chamber by following either barrel tilt or slide manipulation technique previously described in this manual. Align front and rear sight on target, and fire by squeezing the trigger. Be sure to point the muzzle in a safe direction after discharge. The discharge will recoil the slide, eject the fired cartridge case, cock the hammer and activate the recoil spring. The slide will automatically close, feeding the next cartridge from the magazine into the chamber, and the pistol is ready to fire until empty.

NOTE: The slide will close after the last round has been fired, with the chamber empty and the hammer cocked. Lower the hammer.

## **MISFIRE AND/OR HANG-FIRE:**

The model "950 BS Jet Fire" has an exposed hammer for added safety. A shooter can see and feel the exposed hammer in its three positions: fully-lowered (fire), half-cocked (hammer drop catch) or fully-cocked (ready to fire).

Remember—discharge of a chambered cartridge occurs when the hammer drives the firing pin into the primer.

Should you experience a misfire (no discharge) wait at least 15 seconds before relaxing the point of aim as a precaution against hang-fire (delayed discharge due to faulty ammo). If no discharge occurs, the exposed hammer enables you to re-cock the hammer and pull the trigger again. On the second attempt if not discharge occurs, wait 15 seconds and then release the barrel, remove cartridge from chamber and check firing pin indentation in primer. If normal, reload and continue shooting; but if minor or absent, leave gun unloaded and remove the magazine. Cock hammer and with a small instrument (pencil) push firing pin forward, check for damage and free movement, and for hammer's free movement (hold thumb on spur, pull trigger, and swing hammer back and forth).

## **JAMMING/MALFUNCTIONING:**

All Beretta firearms have been designed, manufactured and thoroughly tested to insure durability and trouble-free function. If properly maintained, operated, and loaded with good quality ammunition, malfunction is practically nonexistent.

**NOTE:** Should malfunction (jamming) occur while loading/unloading or shooting, **DO NOT PANIC**—simply keep finger away from the trigger, be sure to point the muzzle in a safe direction; and if possible:

Fully-cock the hammer and engage the Safety.

Release barrel and remove the chambered cartridge.

Remove the Magazine.

Check pistol for damage and mechanical function.

Check ejected cartridges. Do not load with damaged (dented or deformed) ammunition.

## **DRY FIRING:**

Dry Firing can cause firing pin breakage. If you want to practice aim and trigger pull, insert a FIRED cartridge case in the chamber to cushion the fall of the firing pin and eliminate chances of firing pin breakage.

## **DISASSEMBLY:** (Field Stripping of Unloaded Pistol)

1. Remove Magazine by depressing the magazine release button.
2. Release Barrel by pushing the barrel lever forward.
3. Swing the Barrel forward over its hinge to solid stop.
4. Fully-Cock the hammer.
5. Grasp firmly around the front section of the slide with thumb and index finger. Retract the slide about a quarter of an inch—lift the front end of the slide above the frame's barrel hinge, and push the slide forward until it clears the frame's guide lugs.

Further disassembly not recommended.

## **REASSEMBLY:**

Reverse of Disassembly.

1. Elevate the front end of the slide and place the rear end over the frame just in front of the guide lugs. Carefully pull the slide rail over the frame's guide lugs; simultaneously,

- engage the two recoil spring legs into the slide's recesses and ease the slide down to frame engagement.
2. Swing the barrel back to closed position.
  3. Pull and release slide to insure perfect function.
  4. Lower the hammer.
  5. Insert Magazine.

### **CLEANING:**

Clean whenever a notable amount of gunpowder residue, grease and/or lead particles have accumulated in the Action. Your dealer can provide a cleaning kit at little cost.

Use a good grade of light gun oil.

Use a small brush, pipe cleaner, cotton swabs, or small wood applicator to remove dirt, etc.—do not use sharp instrument.

Always clean the barrel thoroughly after shooting using a cleaning rod with a patch, or brush fitting lightly into the chamber and bore—clean the barrel from the chamber. Be sure to recheck the barrel for possible sweat-out a few days after shooting.

Always clean the breech/or bolt face of the slide.

Oil moving parts lightly.

For most effective exterior rust protection, rub a thin film of oil onto the surface with a cloth.

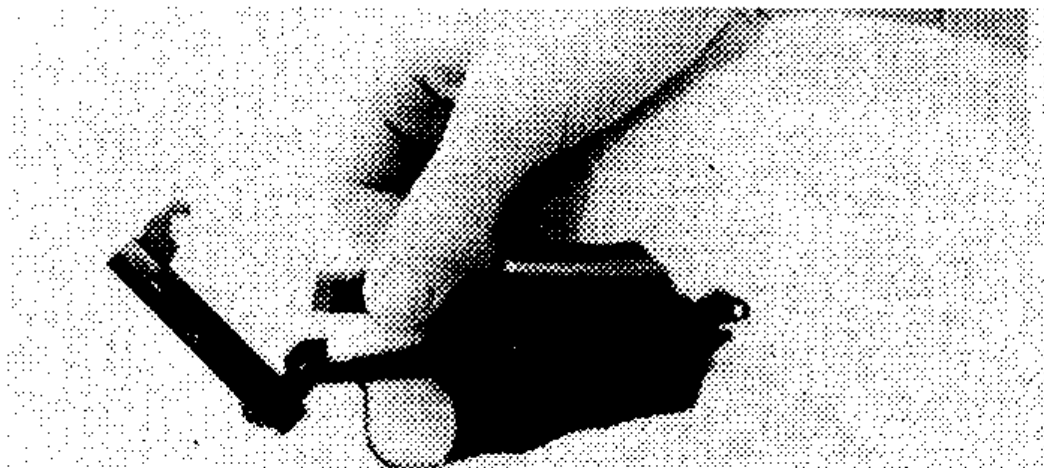
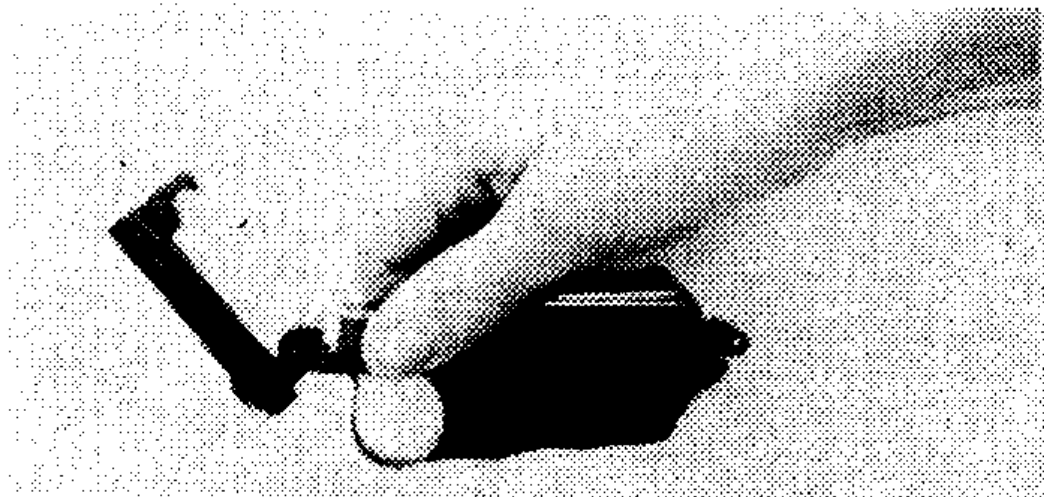



**PARTS LIST MODEL 950 BS JET FIRE**

| No. | Nomenclature                                  | Note |
|-----|---|------|
| 1   | Slide .....                                   | 1    |
| 2   | Barrel compl. 60mm (2.36") .....              |      |
| 4   | Barrel Mounting Pin                           |      |
| 5   | Firing Pi                                     |      |
| 6   | Firing Pin Spring                             |      |
| 7   | Firing Pin Retaining Pin                      |      |
| 8   | Frame .....                                   | 1    |
| 9   | Ejector                                       |      |
| 10  | Barrel Lever                                  |      |
| 11  | Ejector Pin (Rivet)                           |      |
| 12  | Hammer  |      |
| 13  | Hammer/Safety Stop Pin                        |      |
| 14A | Hammer Strut w/Spring Retainer (14-15-16) ... | 2    |
| 17  | Sear  |      |
| 18  | Sear Spring                                   |      |
| 19  | Sear Pin                                      |      |
| 20  | Magazine Release Button                       |      |
| 21  | Magazine Catch Spring                         |      |
| 22  | Magazine Catch                                |      |
| 23  | Recoil Spring                                 |      |
| 24  | Recoil Spring Pin                             |      |
| 25  | Trigger Guard                                 |      |
| 26  | Trigger                                       |      |
| 27  | Trigger Pin                                   |      |
| 28  | Trigger Bar Spring                            |      |
| 29  | Trigger Bar Spring Plunger                    |      |
| 30  | Trigger Bar                                   |      |
| 31  | Trigger Bar Pin                               |      |
| 32  | Left Grip                                     |      |
| 33  | Right Grip                                    |      |
| 34  | Grip Screws (2)                               |      |
| 35A | Magazine (Assembly)                           |      |
| 35  | Magazine Box .....                            | 1    |
| 36  | Follower                                      |      |

## PARTS LIST MODEL 950 BS JET FIRE

| No. | Nomenclature                   | Note |
|-----|--------------------------------|------|
| 37  | Magazine Floorplate Catch      |      |
| 38  | Magazine Floorplate            |      |
| 39  | Magazine Spring                |      |
| 40A | Magazine (Assembly)            |      |
| 40  | Magazine Box                   |      |
| 41  | Follower                       |      |
| 42  | Follower Retaining Screw       |      |
| 43  | Magazine Floorplate catch      |      |
| 44  | Magazine Floorplate see No. 38 |      |
| 45  | Magazine Spring                |      |
| 46  | Barrel Lever Stop Screw        |      |
| 47  | Safety                         |      |
| 48  | Safety Spring                  |      |
|     | Safety Spring Plunger          |      |

**NOTE:**

- 1 Not for sale
- 2 Sold only as Assembly

**Model 950 Specifications**

Overall Length            4.5 inches  
 Length of Barrel        2.5 inches  
 Weight (empty)         8 ounces  
 Magazine capacity      8 rounds  
 Caliber                    .25 (older models may be .22 short)  
 Single action only

## **LIMITED WARRANTY**

**THIS "LIMITED WARRANTY" HAS BEEN DRAFTED TO COMPLY WITH THE MAGNUSON-MOSS WARRANTY FEDERAL TRADE COMMISSION IMPROVEMENT ACT WHICH IS EFFECTIVE FOR GOODS MANUFACTURED ON OR AFTER DECEMBER 31, 1976.**

**Beretta U.S.A. warrants that this firearm was manufactured free of defects in material or workmanship and, for a period of one (1) year after date of original purchase, the Manufacturer agrees to correct any such defects in this firearm by repair or replacement (at Beretta's discretion and, if replaced, with the same or comparable quality firearm). Beretta does not warrant the wood or metal with respect to finish, matching of pieces, dents, scratches, cuts, dings, etc. which are or should be apparent to the purchaser when the product is purchased.**

**It is the customer's responsibility to inspect their particular product prior to purchase to ensure that it is free from defects or damage. Replacement of wood due to defects which could not have been detected prior to purchase will only be made within the regular warranty period.**

**A service and/or handling charge may be made for non-warranty repairs. Return product prepaid to Beretta U.S.A. Corp., Attn: Service Dept., 17601 Beretta Drive, Accokeek, Maryland 20607.**

**BERETTA ASSUMES NO RESPONSIBILITY FOR PRODUCT MALFUNCTION OR FOR PHYSICAL INJURY OR PROPERTY DAMAGE RESULTING IN WHOLE OR IN PART FROM CRIMINAL OR NEGLIGENT USE OF THE PRODUCT, IMPROPER OR CARELESS HANDLING, UNAUTHORIZED MODIFICATIONS, USE OF DEFECTIVE, IMPROPER, HAND-LOADED OR RELOADED AMMUNITION, CUSTOMER ABUSE OR NEGLIGENCE OF THE PRODUCT, OR OTHER INFLUENCES BEYOND BERETTA'S DIRECT AND IMMEDIATE CONTROL. THIS WARRANTY DOES NOT APPLY TO NORMAL WEAR OF ANY PARTS, INCLUDING METAL, WOOD, PLASTIC, RUBBER AND OTHER MATERIAL'S SURFACE FINISH OR IF UNAUTHORIZED REPAIR AND/OR ALTERATION HAS BEEN PERFORMED.**

The terms of the Warranty cannot be changed except in writing by an officer of Beretta U.S.A. Corp.

Wholesalers and Dealers (unless a Beretta U.S.A. Corp. authorized warranty repair station) are not authorized to make any warranty repair or adjustment on behalf of Beretta U.S.A. Corp.

This Warranty gives only the original retail purchaser specific legal rights. Other rights may also be available which may vary from state to state.

Should service be required for this firearm, please return, giving full details of the defect or malfunction, stating date of purchase and dealer from whom the firearm was purchased, along with a copy of your sales receipt.



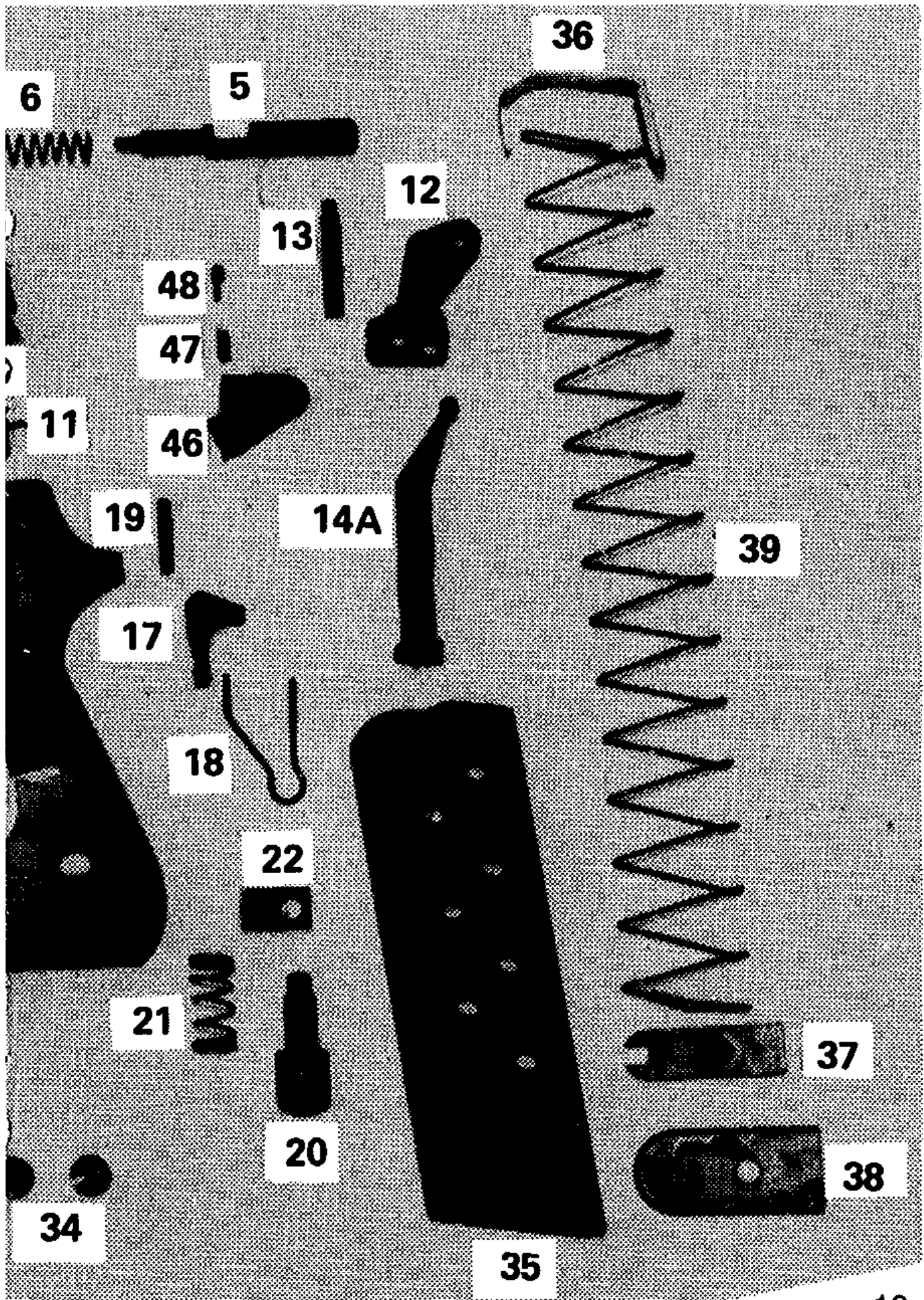



## **Beretta U.S.A. Corp.**

17601 Beretta Drive  
PHONE: (301) 283-2191  
12/93

Accokeek, Maryland 20607  
Telephone: (301) 375-7677