



BROWNING®

The Best There Is.

OWNER'S MANUAL

VERY IMPORTANT:

Save This Booklet. Carefully read this entire manual before using your new Browning firearm.

A-500G

Browning A-500G
Gas Operated
Semi-Automatic
Shotgun

NEW GUN OWNERS RECORD

KEEP THIS RECORD FOR FUTURE REFERENCE

Browning Model

Serial Number

Gauge / Caliber

Purchase Price

Purchased From

Date of Purchase

We are pleased that you have chosen a Browning A-500G shotgun.

It is certainly a gun you can be proud to own. It represents the state-of-the-art in modern gun design and manufacturing. The processes of design, testing and manufacturing were all assisted by advanced computer systems. The result is superior dependability, greater ease-of-operation, smoother handling and more reliable overall function. With a reasonable amount of care, your A-500G shotgun should give you many years of dependable, enjoyable service. Please feel free to write us immediately if you have any observations regarding its performance and operation.

Thank You.



Route One Morgan, Utah 84050

Distributed in Canada by Browning Canada Sports Ltd./Ltee, St-Laurent, Quebec H4S 1W6

Printed in USA KP0063.5

A-500G

Browning A-500G
Gas Operated
Semi-Automatic
Shotgun

You Are Responsible for Firearms Safety

As a gun owner, you accept a set of demanding responsibilities. How seriously you take these responsibilities can be the difference between life and death.

There is no excuse for careless or abusive handling of any firearm. At all times handle your shotgun and any other firearm with intense respect for its power and potential danger.

PLEASE READ AND UNDERSTAND ALL OF THE CAUTIONS, PROPER HANDLING PROCEDURES AND INSTRUCTIONS OUTLINED IN THIS BOOKLET BEFORE USING YOUR NEW FIREARM.

“safety” which blocks the gun’s trigger. See “Operation of the Safety” on page 14 for instructions on operation of this gun’s safety.

LIKE ANY MECHANICAL DEVICE, A “SAFETY” CAN SOMETIMES FAIL; IT CAN BE JARRED OR INADVERTENTLY MANIPULATED INTO AN UNSAFE CONDITION.

Mechanical “safeties” merely aid safe gun handling and are no excuse for pointing your shotgun’s muzzle in an unsafe direction.

While it is a good idea to “test” your shotgun’s mechanical “safeties” periodically for proper function,

NEVER TEST THE “SAFETY” WHILE YOUR SHOTGUN IS LOADED OR POINTED IN AN UNSAFE DIRECTION.

Safe gun handling does not stop with your gun’s mechanical “safety” devices — it starts there. Always treat this

1. ***ALWAYS KEEP THE MUZZLE OF YOUR SHOTGUN POINTED IN A SAFE DIRECTION,***
even though you are certain the shotgun is unloaded. Never point any firearm at anything you do not intend to shoot. Be extremely alert and aware of all persons and property within the range of your ammunition.

2. ***NEVER RELY TOTALLY ON YOUR SHOTGUN’S MECHANICAL “SAFETY” DEVICE.***

The word “safety” describes a gun’s trigger block mechanism, sear block mechanism, hammer block mechanism or firing pin block mechanism. These mechanical devices are designed to place your gun in a *Safer* status. No guarantee can be made that the gun will not fire even if the “safety” is in the “on safe” position. The A-500G has a cross bolt

shotgun with the respect due a loaded, ready-to-fire firearm.

3. ***WHENEVER YOU HANDLE A FIREARM, OR HAND IT TO SOMEONE, ALWAYS OPEN THE ACTION IMMEDIATELY, VISUALLY CHECK YOUR SHOTGUN’S CHAMBER, FEED MECHANISM AND MAGAZINE.***

Make certain that they do not inadvertently contain any ammunition. Always keep the chamber empty and the “safety” in the “on safe” position unless shooting is imminent.

4. ***DO NOT TRANSPORT YOUR SHOTGUN LOADED, WHETHER IN A SCABBARD, GUN CASE, OR OTHER CONTAINER.***

5. ***HUNTING FROM ELEVATED SURFACES SUCH AS TREE STANDS IS DANGEROUS,***

and may increase the risk of handling a firearm. The following rules should

always be observed by you and those you hunt with: Always make certain that the stand being used is safe and stable. Always make certain that your firearm is unloaded when it is being taken up and down from the stand. Always make certain that your firearm is not dropped from the stand, or dropped while it is being taken up or down from the stand. Remember, a loaded firearm may discharge when dropped, even with the safety in the "on safe" position.

- 6. BEWARE OF BARREL OBSTRUCTIONS,** for the safety of both your gun and yourself. Mud, snow, and an infinite variety of other objects may inadvertently lodge in a barrel bore. It takes only one small obstruction to cause dangerously increased pressures that can ruin (swell or rupture) the finest shotgun barrels.

- 7. ALWAYS UNLOAD YOUR SHOTGUN WHEN NOT IN USE. REFER TO PAGE 20 OF THIS INSTRUCTION BOOKLET EXPLAINING THE UNLOADING OF YOUR SHOTGUN.**

As a safety precaution, it is preferable to disassemble your gun for storage. Store your gun and ammunition separately — well beyond the reach of children. Take all safeguards to ensure your shotgun does not become available to untrained, inexperienced or unwelcome hands.

- 8. USE THE PROPER AMMUNITION.**

The barrel and action of this shotgun have been made with substantial safety margins over the pressures developed by established American commercial loads. Nevertheless, Browning assumes no liability for incidents which occur through the use of cartridges of nonstandard dimensions which develop

BEFORE CHECKING FOR A BARREL OBSTRUCTION, BE CERTAIN NO LIVE ROUND IS IN THE CHAMBER AND THAT THE MAGAZINE AND FEED MECHANISMS ARE COMPLETELY EMPTY. PLACE THE "SAFETY" IN THE "ON SAFE" POSITION

See page 23 for instructions on unloading). After assuring yourself that the shotgun is completely empty, again, open the breechblock, locking it to the rear, and look through the barrel to be sure it is clear of any obstruction. If an obstruction is seen, no matter how small it may be, clean the bore with a cleaning rod and patch as described in "Cleaning and Maintenance Suggestions" on page 44. Before the first firing, clean the bore with a cleaning rod and patch, and wipe away any anti-rust compounds in the action/ chamber areas.

pressures in excess of commercially available ammunition which has been loaded in accordance with standards established by the Sporting Arms and Ammunition Manufacturers Institute (SAAMI).

BE ALERT TO THE SIGNS OF AMMUNITION MALFUNCTION.

If you detect an off sound or light recoil when a shell is fired,

DO NOT LOAD ANOTHER SHELL INTO THE CHAMBER.

Open the action and remove all shells from the magazine, chamber and action areas. With the action open, glance down the barrel to make sure that a wad or other obstruction does not remain in the barrel. Completely clear the barrel before loading and firing again. Failure to follow these instructions can cause extensive damage to your gun and possible serious injury to yourself and others.

9. DO NOT PUT A 20 GAUGE SHELL IN A 12 GAUGE GUN.

Store all shells of different gauges in completely separate and well-marked containers. Do not store shells of mixed gauges in a common container or in your pockets.

EXAMINE EVERY SHELL YOU PUT IN YOUR GUN.

The most certain way to bulge or rupture a barrel is to drop a 20 gauge shell into a 12 gauge chamber. The 20 gauge shell, unfortunately, will not fall completely through the barrel; its rim is caught by the front of a 12 gauge chamber. Your gun will misfire (with the chamber appearing to be empty). It is then possible to load a 12 gauge shell behind the 20 gauge shell. If the 12 gauge shell is then fired, the result will be a so-called "12-20 burst" which can cause extensive damage to your gun and possible serious injury to you and others.

13. BE SURE OF YOUR TARGET AND BACKSTOP.

Particularly, be sure during low light periods. Know the range of your ammunition. Never shoot at water or hard objects.

14. ALWAYS UNLOAD YOUR SHOTGUN'S CHAMBER BEFORE CROSSING A FENCE, CLIMBING A TREE, JUMPING A DITCH OR NEGOTIATING OTHER OBSTACLES.

Refer to page 23 of this instruction book for instructions on the unloading of your shotgun. Never place your shotgun on or against a fence, tree, car, or other similar object.

15. WEAR EYE AND EAR PROTECTION WHEN SHOOTING.

Unprotected, repeated exposure to gunfire can cause hearing damage. Wear ear protectors (shooting ear plugs or

10. CAUTION: DO NOT USE 3 1/2" SHOTGUN SHELLS IN ANY SHOTGUN OR BARREL WITH A 2 3/4" OR 3" CHAMBER. DO NOT USE 3" SHELLS IN SHOTGUN CHAMBERED FOR 2 3/4" SHELLS. THE SIZE OF THE CHAMBER IS INSCRIBED, ALONG WITH GAUGE AND CHOKE DESIGNATIONS, ON THE SIDE OF THE BARREL.

Your A-500 is chambered for factory 2 3/4" and 3" shells only.

11. DO NOT SNAP THE FIRING PIN ON AN EMPTY CHAMBER — THE CHAMBER MAY NOT BE EMPTY!

Treat every gun with the respect due a loaded gun, even though you are certain the gun is unloaded.

12. KEEP YOUR FINGERS AWAY FROM THE TRIGGER WHILE UNLOADING, LOADING, UNTIL YOU ARE READY TO SHOOT.

muffs) to guard against such damage. Wear shooting glasses to protect your eyes from flying particles. Also, wear eye protection when disassembling and cleaning your shotgun to prevent the possibility of springs, spring-tensioned parts, solvents or other agents from contacting your eyes.

16. DROPPING A LOADED GUN CAN CAUSE AN ACCIDENTAL DISCHARGE even with the "safety" in the "on safe" position. Be extremely careful while hunting or during any shooting activity, to avoid dropping any firearm.

17. IF YOUR SHOTGUN FAILS TO FIRE, KEEP THE MUZZLE POINTED IN A SAFE DIRECTION.

Hold this position for a minimum of 30 seconds. Carefully open the action and remove the cartridge. If the primer is indented, the cartridge should be

disposed of in a way that cannot cause harm. If the primer is not indented, your firearm should be examined by a qualified gunsmith and the cause of the malfunction should be corrected before further use.

18. BE DEFENSIVE AND ON GUARD AGAINST UNSAFE GUN HANDLING AROUND YOU AND OTHERS.

Don't be timid when it comes to gun safety. If you observe other shooters violating any of these safety precautions, politely suggest safer handling practices.

19. BE CERTAIN YOUR SHOTGUN IS UNLOADED BEFORE CLEANING.

Because so many gun accidents occur when a firearm is being cleaned, special and extreme care should be taken to be sure your gun is unloaded before

disassembly, cleaning and reassembly. Keep ammunition away from the cleaning location. Never test the mechanical function of any firearm with live ammunition.

20. EDUCATE AND SUPERVISE FIREARMS SAFETY TO ALL MEMBERS OF YOUR FAMILY— ESPECIALLY TO CHILDREN AND NONSHOOTERS.

Closely supervise newcomers to the shooting sports. Encourage enrollment in hunting/shooting safety courses.

21. NEVER DRINK ALCOHOLIC BEVERAGES OR TAKE ANY TYPE OF DRUGS BEFORE OR DURING SHOOTING.

Your vision and judgment could be dangerously impaired, making your gun handling unsafe to you and to others.

22. READ AND HEED ALL WARNINGS IN THIS INSTRUCTION BOOK AND ON AMMUNITION BOXES.

It is your responsibility to secure the most up-to-date information on the safe handling procedures for your Browning gun. Browning cannot assume any responsibility when unsafe or improper arms and ammunition combinations are used.

23. PERIODIC MAINTENANCE— AVOID UNAUTHORIZED SERVICING.

Your shotgun is a mechanical device which will not last forever, and as such, is subject to wear and requires periodic inspection, adjustment, and service. Browning firearms should be serviced by a Browning Recommended Service

Center or by Browning's service facility in Arnold, Missouri. Browning cannot assume any responsibility for injuries suffered or caused by unauthorized servicing, alterations or modifications of Browning firearms.

IT CAN BE VERY DANGEROUS TO ALTER THE TRIGGER, SAFETY OR OTHER FIRING MECHANISM PARTS OF THIS OR ANY OTHER FIREARM.

BE CAREFUL!

Nomenclature

In conventional gun terminology, the position and movement of gun parts are described as they occur with the gun horizontal and in normal firing position; i.e., the muzzle is forward or front; butt stock is rearward or rear; trigger is downward or underneath; the rib is upward or on top. For general parts nomenclature refer to Figure 1-A. See Figure 1-B for names of all parts and assemblies covered in disassembly and cleaning procedures.

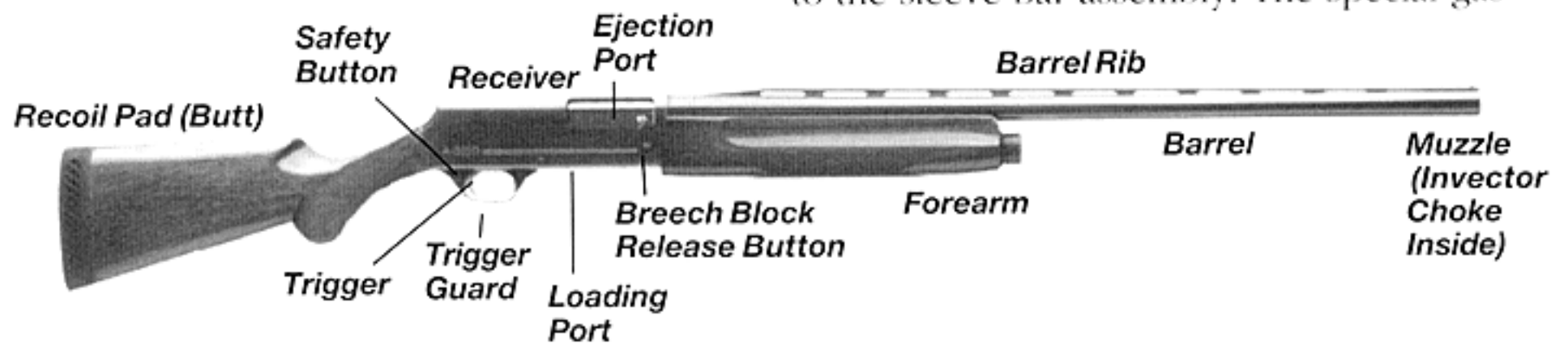
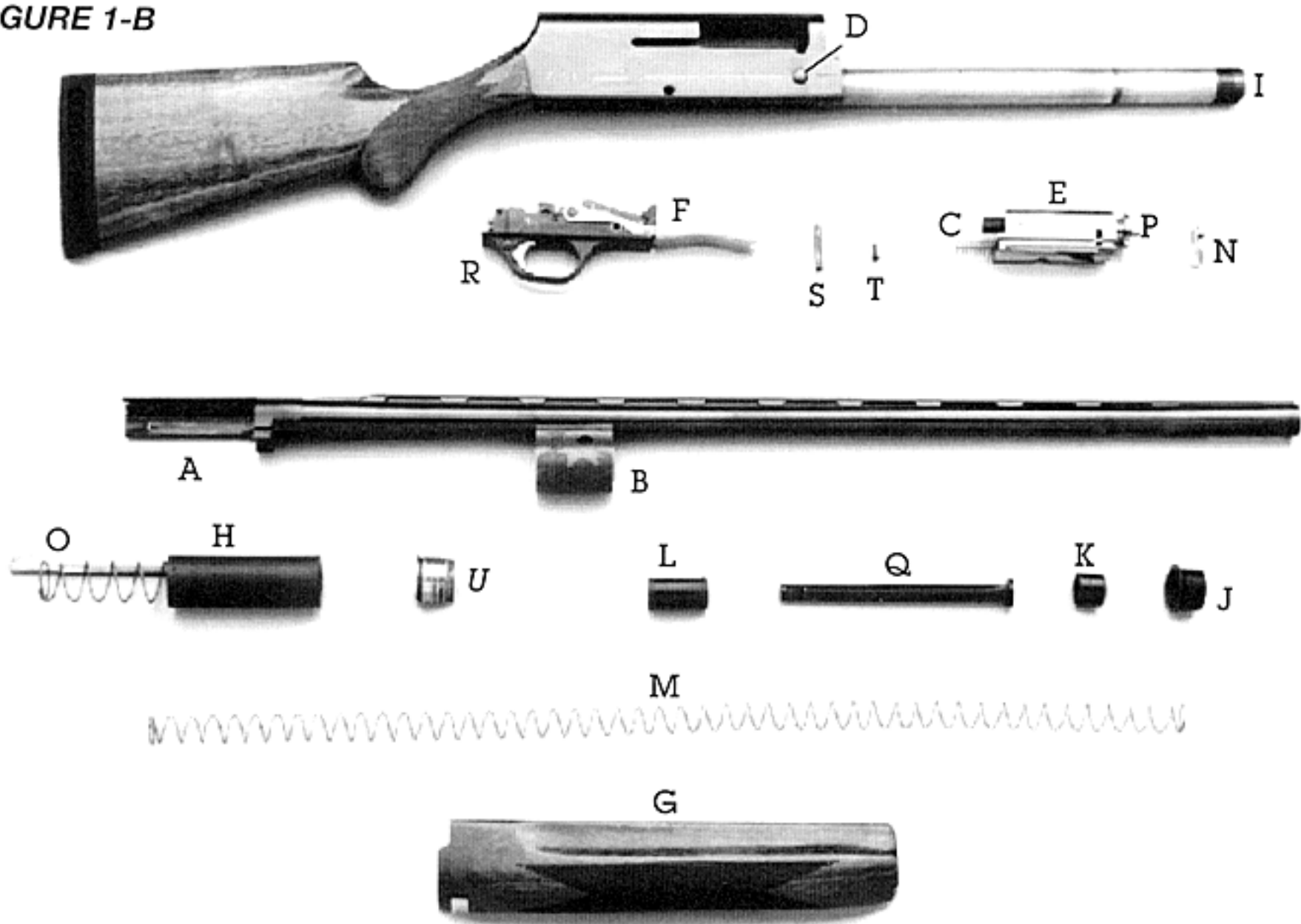

FIGURE 1-A

General Operating Procedures

The Browning A-500G shotgun is a gas-operated, semi-automatic shotgun. It is capable of shooting five shots (with the magazine plug removed) in rapid succession with each pull of the trigger. The rotary bolt locks into the barrel with four lugs. Upon firing, high pressure gas from the barrel passes through two ports in the barrel, through the barrel ring guide and into the gas cylinder. The high pressure gases force the gas piston rearward, applying pressure to the sleeve bar assembly. The special gas

FIGURE 1-B



A. Barrel Extension Guides
 B. Barrel Ring Guide/Gas Cylinder
 C. Front Action Springs
 D. Bolt Release Button (Carrier Latch Button)
 E. Breechblock Assembly
 F. Carrier
 G. Forearm
 H. Sleeve Bar Assembly
 I. Magazine Tube
 J. Magazine Cap
 K. Magazine Spring Retainer

L. Magazine Follower
 M. Magazine Spring
 N. Operating Handle
 O. Return Spring
 P. Rotary Bolt Head
 Q. Three Shot Adapter
 R. Trigger Group
 S. Trigger Guard Retaining Nut
 T. Trigger Guard Retaining Screw
 U. Gas Piston

pressure regulation valve releases excess gas pressure that is not necessary for operating the action. This keeps bolt speed more consistent and allows you to shoot all factory 2 3/4" and 3" loads interchangeably, without adjustment. As the piston moves the sleeve reward, the action bar—which extends from the sleeve—pushes the breechblock rearward, operating the action. As the breechblock moves rearward, it turns and unlocks the 4-lug rotary bolt, recocks the hammer, and ejects the fired shell.

After full rearward travel, the breech-block returns forward, picking up a new shell from the magazine and chambering it automatically. After the last shell has been fired, the breechblock locks to the rear, instead of returning forward. This facilitates speedy, convenient reloading.

NOTE: The A-500G is delivered with the magazine adaptor in the magazine which limits the gun to three shots, in accordance with federal migratory bird laws. If you do not want your gun to be so lim-

ited, merely take out the three shot adapter as explained on page 34 under "Three Shot Adapter."

Serial Number

The serial number of your A-500G shotgun is found on the left side of the receiver, at the lower rear, near the grip portion of the buttstock.

Initial Cleaning

Various exposed metal parts of your new A-500 have been coated at the factory with a rust preventative compound. Before assembling your A-500G, clean the anti-rust compound from the inside of the barrel, receiver and the action/ chamber areas. Browning Oil is ideal for removing this compound and for giving your new gun its first lubrication. However, any quality gun oil may be used. Use a cleaning rod and patch as explained under "Cleaning and Maintenance Suggestions" on page 44.

Ammunition

The A-500G has a 3-inch chamber and is designed to shoot and function with all 12 gauge factory loads: 3-inch Magnum, 2 3/4" Magnum, 2 3/4" High Velocity loads, 2 3/4" Field and 2 3/4" Target loads. It is especially suited to shooting factory steel shot loads. Loads can be intermixed, in any order. Browning can assume no responsibility for incidents which occur through the use of cartridges of nonstandard dimension or those developing pressures in excess of standards established by the Sporting Arms and Ammunition Manufacturer's Institute (SAAMI).

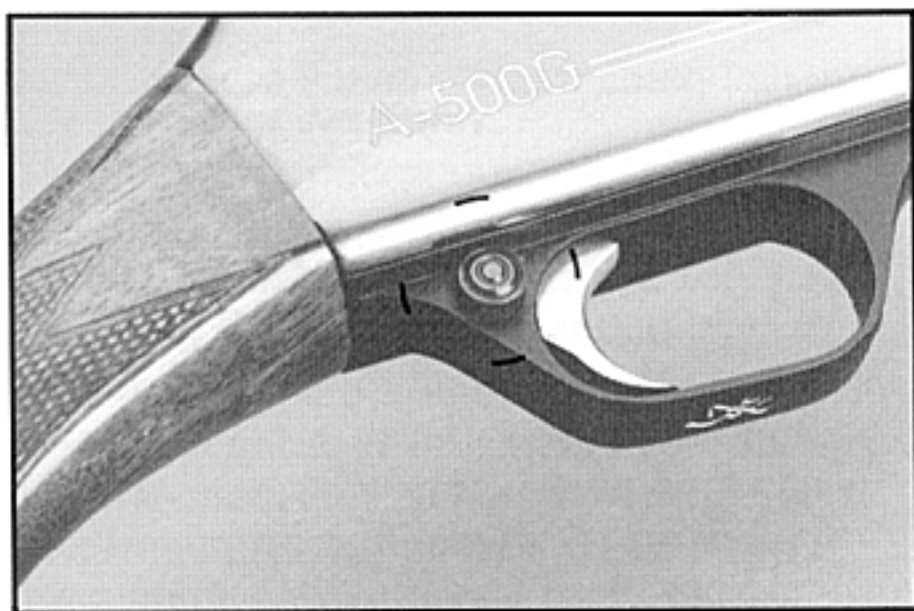
FIGURE 2

Operation of the “Safety”

The cross bolt “safety” prevents the trigger from being pulled when in the “on safe” position. The safety is located conveniently at the rear of the trigger guard (See Figure 2). In the “off safe” or “fire” position a

As previously explained, never rely on your shotgun’s mechanical “safety” devices as the sole provision for safety.

NEVER POINT YOUR SHOTGUN AT ANYTHING YOU DO NOT INTEND TO SHOOT.

Always treat your shotgun, even when unloaded, with the respect due any loaded, ready-to-fire firearm.

Assembly of Barrel and Gas System Components

CHECK YOUR GUN CAREFULLY TO BE ABSOLUTELY CERTAIN THAT THE CHAMBER, FEED MECHANISM AND MAGAZINE CONTAIN NO SHELLS.

conspicuous red warning band is visible on the safety button on the left side of the trigger guard. To place the gun “ON **SAFE**,” press the “safety” button to the right. To move the “safety” to the **FIRE** position, press the “safety” to the left.

The safety is reversible and can be reversed from right- to left-handed by a competent gunsmith. When installed, the left-handed “safety” will have the “safety” button’s red warning band on the **RIGHT** side of the trigger guard.

DO NOT DEPEND ON THE RED COLOR ALONE TO INDICATE YOUR GUN’S SAFETY STATUS.

Time, exposure to the elements, as well as the abrasive action of cleaning agents can erase it.

The A-500G is delivered, in the box, with the barrel removed and the forearm—with the gas piston, sleeve bar assembly and return spring inside—assembled on the magazine tube. Perform the following steps to assemble your A-500G and make it ready for shooting.

1. Take the receiver in hand. First, lock the breechblock rearward by pulling the operating handle fully to the rear. Then remove the forearm from the magazine tube by unscrewing the magazine cap and sliding the forearm forward, off of the magazine tube.

DO NOT SQUEEZE HARD ON THE OPEN REAR END OF THE FOREARM. TOO MUCH PRESSURE COULD CAUSE THE WOOD TO SPLIT.

FIGURE 3

2. The gas piston, sleeve bar and return spring will remain in place and do not need to be removed, except for cleaning. If the forearm assembly parts have been removed, reinstall them as explained below. Otherwise, proceed to step 6.
3. Insert the return spring into the round hole in the end of the sleeve portion of

FIGURE 4

the sleeve bar assembly — the end which has the action bar protruding — not in the ten sided, decagon-shaped end (See Figure 3). It is important to note that the diameter of the spring is different on each end. The large end is inserted into the sleeve. The smaller diameter end goes toward the end of the action bar.

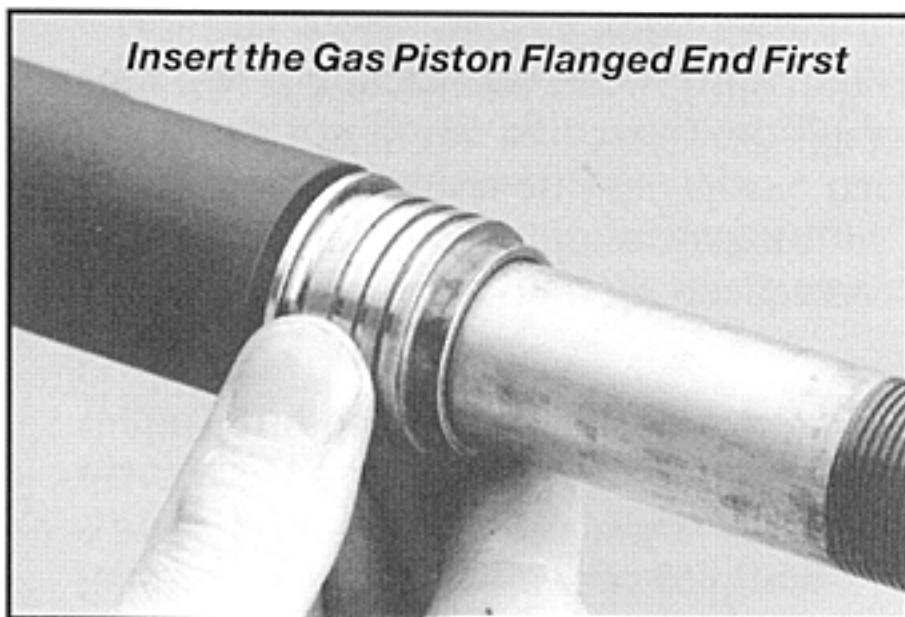
FIGURE 5

4. Slide the sleeve bar assembly onto the magazine tube with action bar and return spring first. Align the end of the action bar so it rides in the track on the left side of the receiver (See Figure 4).
5. Insert the gas piston onto the magazine tube, flanged end first. Slide it down to the sleeve bar assembly (See Figure 5).
6. With the gun in the horizontal position,

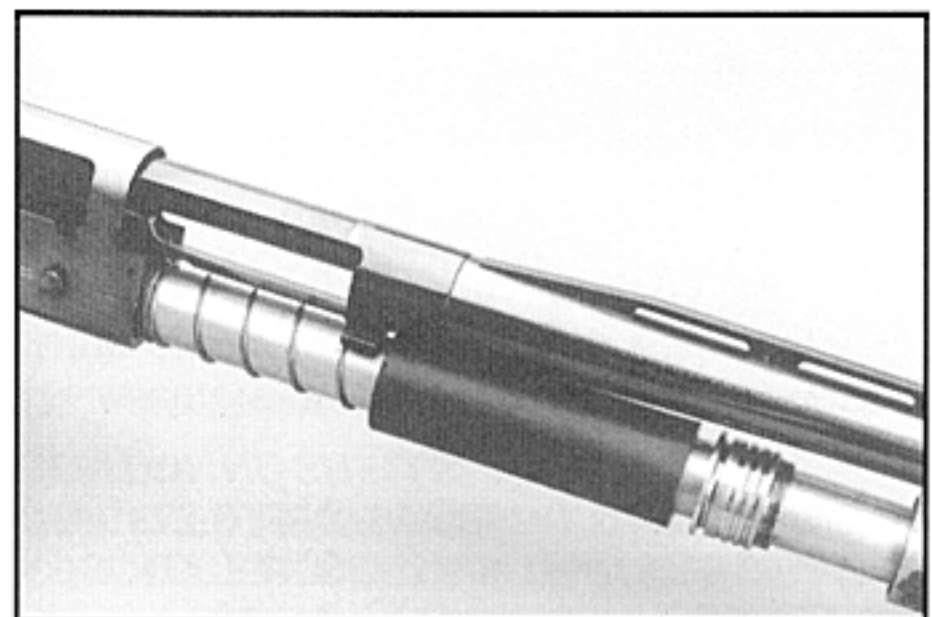
FIGURE 6

ejection port up, attach the barrel by sliding the barrel guide ring/gas cylinder over the magazine tube. You will need to slide the sleeve bar and return spring forward about 1/2" toward the end of the magazine tube in order for the barrel extension rails to fit behind the sleeve and allow the rails to properly engage in the receiver tracks (See Figure 6). Do not

slide it so far forward that the end of the action bar disengages from the track in the receiver.

7. When the barrel extension rails are fully seated in the receiver tracks, position your shotgun vertically, barrel up. The barrel extension will usually hang up slightly where the end of the extension contacts the face of the rotary bolt, and at this point is only partly engaged. To fully seat the extension rails pull rearward on the operating handle (several times if necessary) until the bolt rotates slightly and the barrel slips solidly into position.
8. Replace the forearm onto the magazine tube by sliding it onto the magazine tube, over gas piston and the sleeve bar assembly. Install the magazine cap. Make sure that the magazine cap is fully tight-
3. For cleaning, remove the gas piston and sleeve bar assembly by sliding them forward off of the magazine tube. It is not necessary to disassemble any part of the gas pressure regulation valve. See "Cleaning and Maintenance Suggestions" on page 44 for suggested cleaning procedures.

If you are disassembling for storage, return the sleeve bar assembly and the gas piston onto the magazine tube as shown previously in Figure 6. Reinstall the forearm over the magazine tube and screw on the magazine cap. You will then have two compact units: the barrel, and the action with forearm and stock.

CAUTION: AFTER THE BARREL HAS BEEN REMOVED FROM YOUR GUN, LEAVE THE BREECHBLOCK IN THE OPEN POSITION. DO NOT PRESS THE BOLT RELEASE BUTTON.

ened down. If the magazine cap threads won't engage the magazine tube threads the barrel extension is still not properly seated. You must repeat step 7 until it fully engages. Your A-500G is now fully assembled.

Disassembly of Barrel and Gas System Components

CHECK YOUR GUN CAREFULLY TO BE ABSOLUTELY CERTAIN THAT THE CHAMBER, FEED MECHANISM AND MAGAZINE CONTAIN NO SHELLS.

Disassembly of the barrel from the receiver is important for cleaning and is also a convenient way to store your A-500G.

1. Unscrew the magazine cap.
2. Remove the forearm by sliding it forward on the magazine tube.

If the breechblock is released forward with the barrel removed, the operating handle will be driven against the edge of the ejection port, which will cause damage to the receiver.

Loading Procedures

There are two basic methods for initially getting a loaded shell into the chamber of your A-500G.

CAUTION: AT ALL TIMES DURING THE LOADING PROCEDURE, BE SURE YOUR MUZZLE IS POINTING IN A SAFE DIRECTION AND THE "SAFETY" IS IN THE "ON SAFE" POSITION. REMEMBER: DO NOT PUT A 20 GAUGE OR 3 1/2" MAGNUM SHELL IN YOUR A-500G 12 GAUGE SHOTGUN. NEVER STORE SHELLS OF MIXED GAUGES IN A COMMON CONTAINER OR IN YOUR POCKETS.

See caution number 8 on page 5 of this booklet for an explanation.

CAUTION: WHENEVER A SHELL HAS BEEN CYCLED INTO THE CHAMBER—DURING LOADING OR ANY OTHER TIME, AUTOMATICALLY OR MANUALLY—THE SHOTGUN IS READY TO FIRE BY SIMPLY MOVING THE “SAFETY” TO THE OFF SAFE POSITION.

METHOD ONE: LOADING THE CHAMBER THROUGH THE EJECTION PORT —

1. After making sure the “safety” is “on safe,” pull the operating handle to the rear until the breechblock locks in the open position.

proper gauge through the ejection port into the open breech (See Figure 7). Press the breechblock release button.

KEEP YOUR FINGERS CLEAR OF THE EJECTION PORT.

This will automatically cause the shell to be picked up and delivered to the chamber correctly. The chamber is now loaded.

3. With the chamber loaded, load the magazine to full capacity as explained below under “Loading the Magazine.”

METHOD TWO: LOADING THE CHAMBER MANUALLY FROM THE MAGAZINE —

1. Make sure the muzzle is pointed in a safe direction and the “safety” is in the “on safe” position.
2. To load the magazine, follow the instructions under “Loading the Magazine”

FIGURE 7



VISUALLY INSPECT THE CHAMBER, CARRIER, AND MAGAZINE TO MAKE SURE THEY ARE CLEAR OF ANY OBSTRUCTIONS.

2. While pointing the muzzle in a safe direction, hold your A-500G with the ejection port up, and insert a cartridge of the

listed below. With the magazine loaded, and the breechblock closed, merely pull back on the operating handle, fully to the rear, and release it, allowing the breechblock to close. This will automatically cycle a shell from the magazine to the chamber.

3. To again load the magazine to full capacity, thumb another shell into the magazine as explained below under “Loading the Magazine.”

LOADING THE MAGAZINE —

1. **MAKE SURE THE MUZZLE IS POINTED IN A SAFE DIRECTION AND THE “SAFETY” IS IN THE “ON SAFE” POSITION.**
2. Close the breechblock by pressing the breechblock release button (as explained above).

FIGURE 8

MAKE SURE YOUR FINGERS ARE CLEAR OF THE EJECTION PORT.

3. Insert a shell, of the proper gauge, through the loading port at the bottom of the receiver, up into the magazine, using your thumb to position it fully forward in the magazine tube (See Figure 8). Make

Unloading your A-500G

CAUTION: WHENEVER UNLOADING, ALWAYS BE CERTAIN THAT THE MUZZLE IS POINTED IN A SAFE DIRECTION AND THAT THE "SAFETY" IS IN THE "ON SAFE" POSITION.

1. One way to unload the A-500G is simply to grasp the operating handle and cycle the action until all rounds are ejected.
2. The magazine can also be unloaded manually by reaching inside the loading port with your index finger, and simultaneously pressing in on the bottom of the carrier and pressing the carrier latch (See Figure 18 on page 36). Release and remove one shell at a time from the magazine, until empty. Remove the shell from the chamber by cycling the action.

sure the rim of the shell engages the carrier latch and is held fully inside the magazine tube. It will make an audible click when fully inserted. Repeat this procedure until the magazine is fully loaded.

CAUTION: WHENEVER A SHELL HAS BEEN CYCLED INTO THE CHAMBER—AUTOMATICALLY OR MANUALLY—THE SHOTGUN IS READY TO FIRE BY SIMPLY MOVING THE "SAFETY" TO THE OFF SAFE POSITION.

MAGAZINE CAPACITY —

With the three shot adapter installed, the magazine will hold TWO 2 3/4" or 3-inch shells. With the three shot adapter removed, the magazine holds FOUR 2 3/4" or THREE 3-inch shells.

ALWAYS INSPECT THE CHAMBER, ACTION, CARRIER AND MAGAZINE VERY CAREFULLY AFTER UNLOADING TO BE SURE ALL LIVE ROUNDS ARE CLEARED FROM THE GUN.

Breech Remains Open After the Last Shot

The breech of the A-500G remains open, with the breechblock locked to the rear, after the last shot has been fired. This allows convenient and fast reloading as follows:

1. Place the "safety" in the "on safe" position.
2. Drop an appropriate shell into the open breech.
3. Close the action by depressing the breechblock release button.

BROWNING A-500G GAS OPERATED SEMI-AUTOMATIC SHOTGUN

Schematic is provided for parts identification only and should not be used as a guide to assemble guns.

IMPORTANT: When ordering parts, list part number, part name, caliber, model and serial number.

CAUTION: Browning parts are made exclusively for Browning guns and are not recommended for use in other guns even though models may be similar. Inadequately fitted parts may be dangerous.

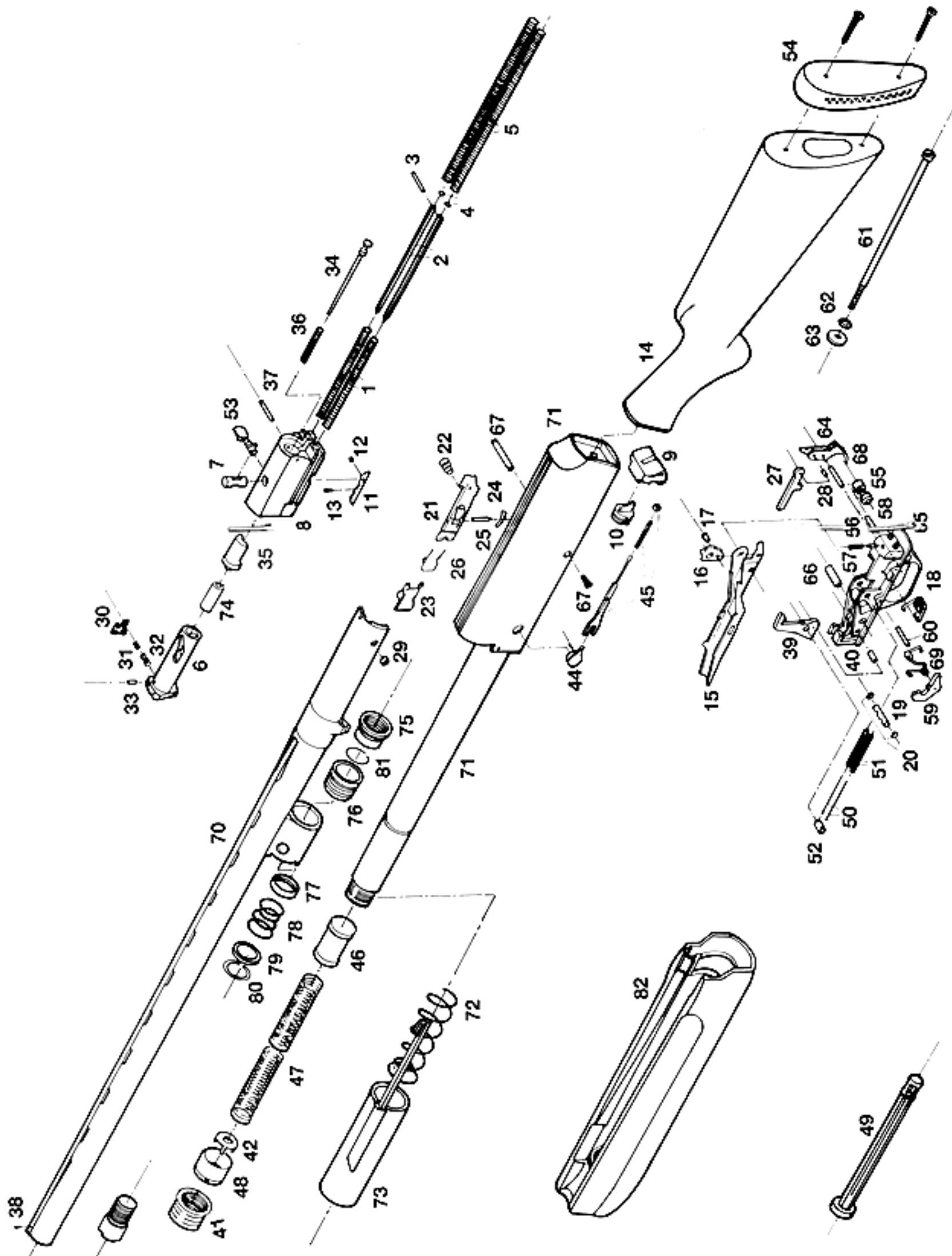

KEY NO.	BROWNING PART NO.	DESCRIPTION	KEY NO.	BROWNING PART NO.	DESCRIPTION	KEY NO.	BROWNING PART NO.	DESCRIPTION
1	P014001	Action Spring Front (2)	29	P014155	Ejector	*56	P014324	Safety Plunger
2	P014006	Action Spring Guide (2)	30	P014160	Extractor	57	P014328	Safety Plunger Spring
3	P014007	Action Spring Guide Pin	31	P014164	Extractor Inner Spring	58	P014332	Safety Spring Stop Pin
4	P014012	Action Spring Guide Washer	32	P014168	Extractor Outer Spring	*59	P014340	Sear
5	P014016	Action Spring Rear (2)	33	P014172	Extractor Pin	60	P014344	Sear Pin
*6	P014030	Bolt Assembly	34	P014178	Firing Pin	61	P014350	Stock Screw
7	P014034	Bolt Cam Pin	35	P014182	Firing Pin Cover	62	P014354	Stock Screw Lock Washer
*8	P014044	Breech Block	36	P014186	Firing Pin Spring	63	P014358	Stock Screw Washer
*9	P014048	Breech Block Buffer	37	P014190	Firing Pin Stop Pin	*64	P014364	Trigger
*10	P014052	Breech Block Buffer Core	38	P014210	Front Sight	65	P014370	Trigger Guard Assembly
*11	P014056	Breech Block Lever	*39	P014215	Hammer	66	P014375	Trigger Guard Pin Sleeve
12	*P014060	Breech Block Lever Pin	40	P014220	Hammer Pin	67	P014385	Trigger Guard Screw & Nut Assembly
13	P014065	Breech Block Lever Spring	41	P014225	Magazine Cap	68	P014390	Trigger Pin
14	P014076	Butt Stock	42	P014230	Magazine Cap Retainer	69	P014395	Trigger Spring
*15	P014084	Carrier	43	P014234	Magazine Cap With Eyelet	70	P014420	Barrel Extension
*16	P014089	Carrier Dog	44	P014240	Magazine Cutoff & Pin	71	P014404	Magazine Tube
17	P014095	Carrier Dog Pin	45	P014248	Magazine Cutoff Plunger Assembly	**71	P014415	Receiver
*18	P014101	Carrier & Car Dog Spring	46	P014262	Magazine Follower	72	P014422	Return Spring
19	P014105	Carrier Pin	47	P014268	Magazine Spring	73	P014424	Sleeve Bar
20	P014110	Carrier Pin Circlip	48	P014274	Magazine Spring Retainer	74	P014426	Intermediate Tube
*21	P014115	Carrier Latch	49	P014280	Magazine 3-Shot Adapter A-500	75	P014428	Rear Piston
22	P014120	Carrier Latch Spring	50	P014286	Mainspring	76	P014429	Front Piston
*23	P014125	Cartridge Stop	51	P014290	Mainspring Guide	77	P014430	Regulation Valve
24	P014130	Cartridge Stop & Carrier Latch Pin	52	P014294	Mainspring Guide Pin	78	P014432	Regulation Spring
25	P014134	Cartridge Stop & Pin Clip	53	P014302	Operating Handle	79	P014434	Centering Washer
26	P014138	Cartridge Stop Spring	54	P208466	Recoil Pad	80	P014436	Locking Ring
*27	P014144	Disconnecter	*55	P014320	Safety	81	P014470	Bearing Ring
28	P014148	Disconnecter Pin				82	P014496	Forearm

* Indicates part must be fitted by Browning Service Department or by a Browning Recommended Service Center.
**Part may be purchased by holders of current, valid Federal Firearms License.

4. Load the magazine as explained above under "Loading the Magazine" on page 23.

EVEN WITH THE BREECH LOCKED OPEN AFTER SHOOTING, DO NOT ASSUME YOUR SHOTGUN IS UNLOADED. ALWAYS INSPECT THE CHAMBER, CARRIER AND MAGAZINE TUBE TO BE SURE THEY CONTAIN NO CARTRIDGES. THEN, REMEMBER TO ALWAYS TREAT ANY GUN AS IF IT WAS LOADED. ALWAYS HANDLE YOUR SHOTGUN WITH CAUTION.

Operation of the Magazine Cut-off

The magazine cut-off lever is located at the front end of the left side of the receiver. This cut-off has the purpose of locking the shells in the magazine so that they will not feed into the chamber. This permits you to quickly change the load in the chamber of the gun without going to the trouble of un-

FIGURE 9-A

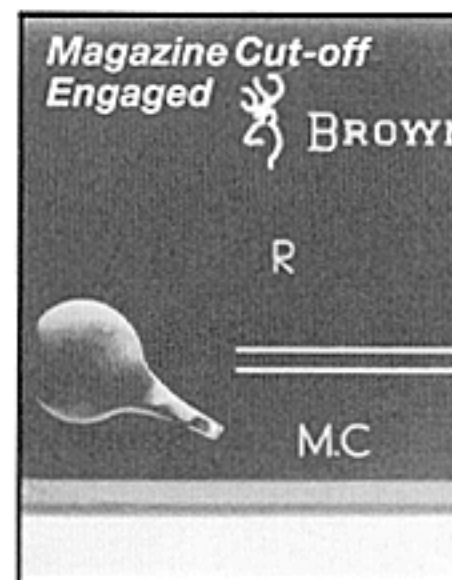
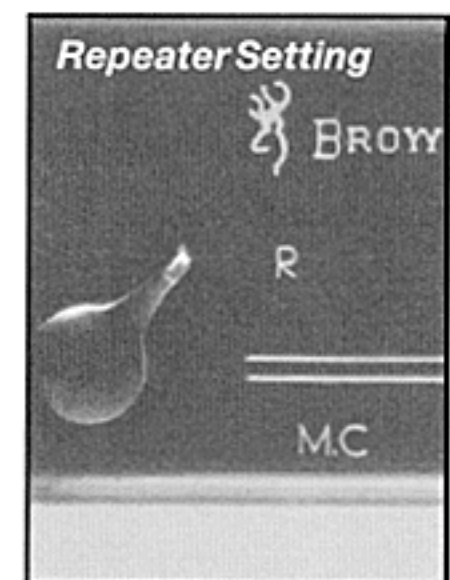

FIGURE 9-B



loading the whole magazine. For instance, in this way a duck load can quickly be taken out and a goose load inserted, if the need arises. To operate the magazine cut-off, merely manipulate the lever to the "MC" or "R" positions. The "MC" position engages the magazine cutoff (See Figure 9-A). The "R" position (See Figure 9-B) places the magazine in conventional repeater posi-

tion, chambering a shell from the magazine each time the breechblock cycles rearward (as when you shoot or manually cycle the breechblock). Also, with the magazine cut-off in operation, and with the chamber empty and the breechblock locked in the rearward position, a loaded shell may be instantly delivered from the magazine to the chamber by merely moving the lever from the "MC" position (magazine cut-off), to the "R" (repeater) position. When the breechblock is locked rearward,

BE CAREFUL TO KEEP YOUR FINGERS CLEAR OF THE LOADING PORT AND EJECTION PORT WHEN MOVING THE LEVER FROM "MC" TO "R".

REMOVING THE TRIGGER GROUP —

You will need two medium blade screwdrivers to remove the trigger guard retaining screws (the trigger guard retaining nut and the trigger guard retaining screw). Make sure the screwdrivers are of appropriate size to prevent damage to the slotted heads. No other tools are necessary.

1. Remove the barrel as explained under "Disassembly" on page 18. Set the forearm, as well as the forearm buffer and spring, aside.
2. Release the breechblock to its forward position as follows: While holding the operating handle back (by applying rearward pressure) depress the breechblock release button. Allow the breechblock to travel slowly forward, controlling and slowing its forward travel until it is fully forward. The head of the rotary bolt

Full Disassembly: Trigger Group and Breechblock

It is not necessary or recommended that the trigger group or breechblock be removed except if a malfunction occurs, or if the action becomes excessively dirty or wet. If this occurs, disassemble the action for a complete cleaning as explained below. Detailed cleaning procedures are outlined under "Cleaning and Maintenance" on page 44. Full disassembly involves removal of the breechblock assembly and the trigger group. Any disassembly beyond this should only be performed by a competent gunsmith.

ALWAYS WEAR EYE PROTECTION WHEN PERFORMING ANY MAINTENANCE OR DISASSEMBLY.

FIGURE 10

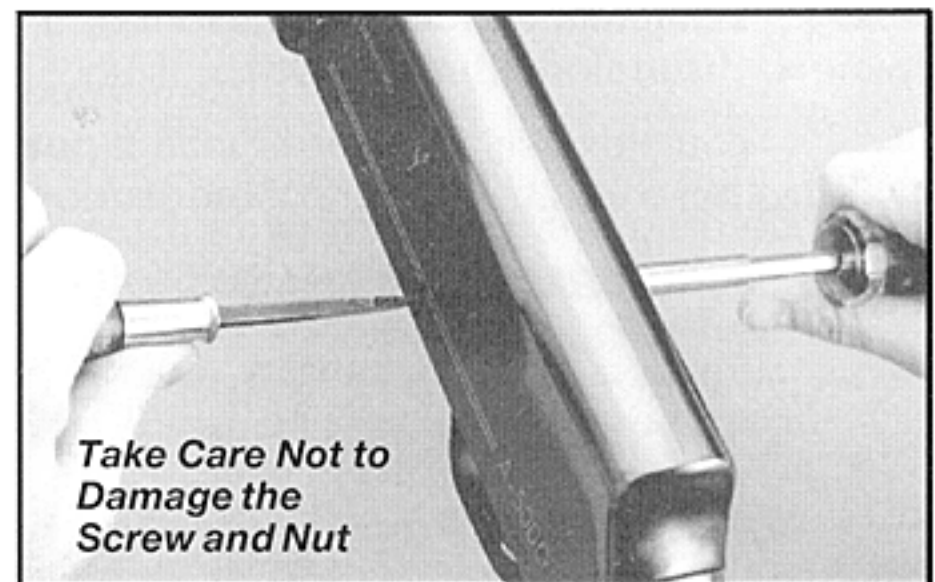

should project about 1/2" from the front of the receiver.

3. Insert a screwdriver into the retaining nut slot and the other screwdriver into the retaining screw slot. Hold one side from turning while unscrewing the opposite side (See Figure 10).

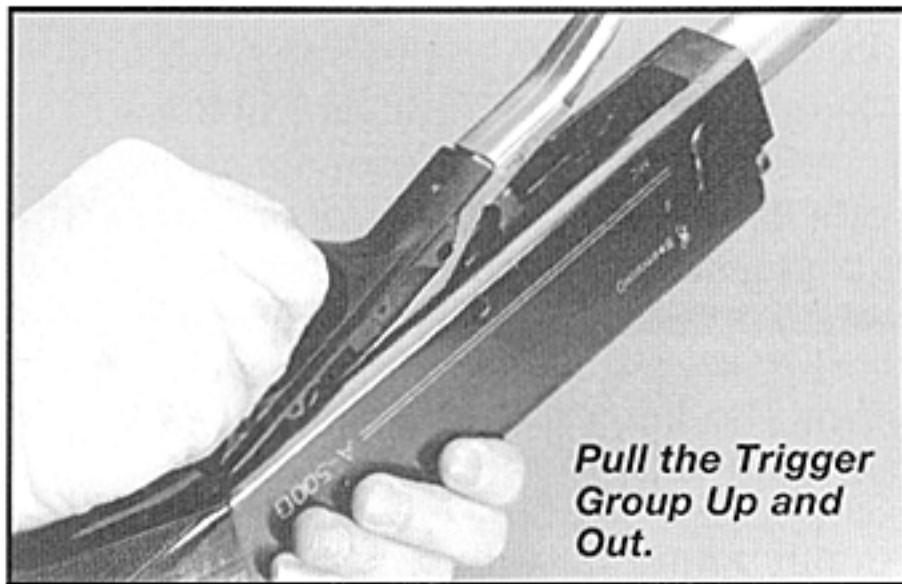
FIGURE 11

4. Remove the retaining nut and screw from the receiver.
5. With the gun inverted (trigger guard up), grasp the trigger guard and pull it up, forward and out from the receiver (See Figure 11).

DO NOT DISASSEMBLE THE TRIGGER GROUP BEYOND THIS POINT.

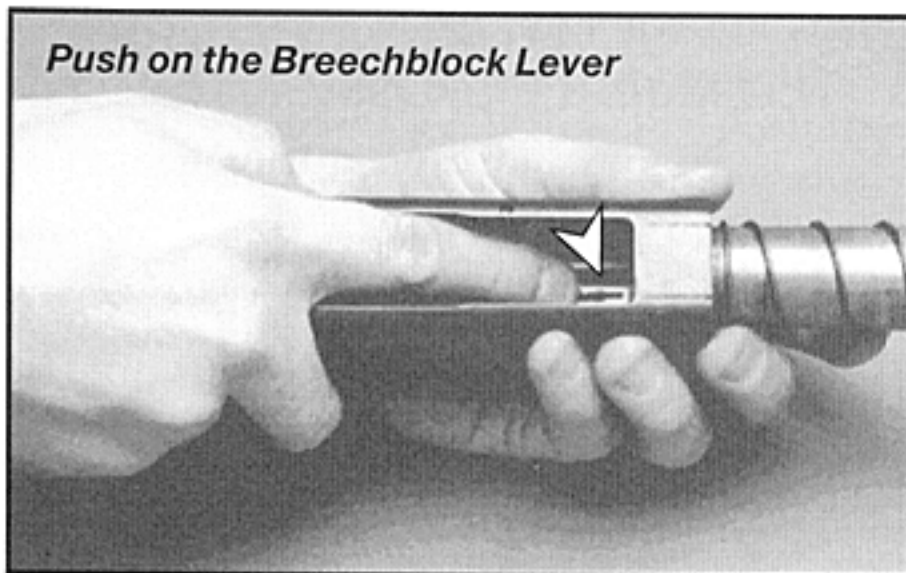
FIGURE 13

With your left hand, push on the bolt head moving the breechblock about 1/2" back into the receiver, lining up the operating handle with the notch at the bottom front of the ejection port (See Figure 12-A). With your right hand grasp the operating handle and pull it outward, removing it from the breechblock (See Figure 12-B).

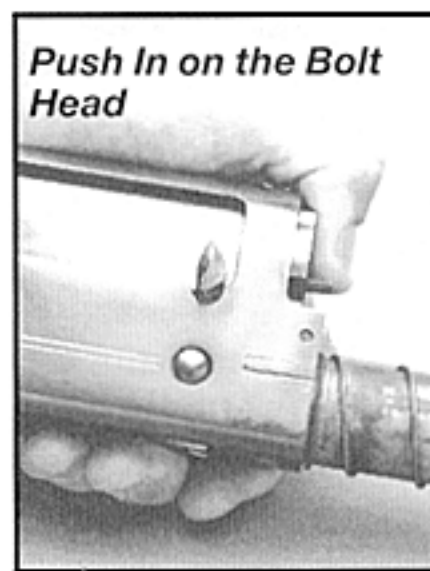
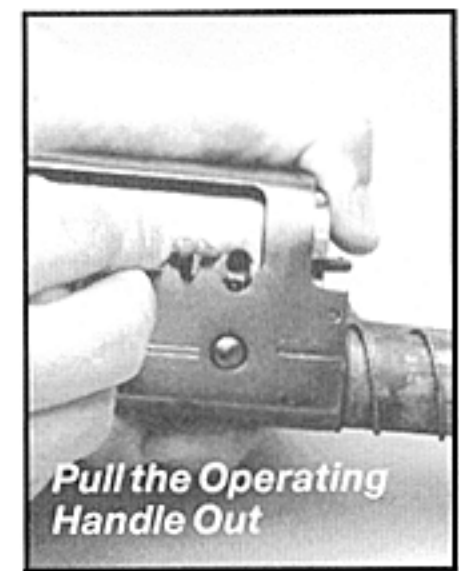
FIGURE 12-A**FIGURE 12-B**

Perform all cleaning with the trigger group kept intact as an assembly.

REMOVING THE BREECHBLOCK —

Normal procedure is to remove the barrel and trigger group first, as explained previously.

1. Remove the operating handle as follows:
 2. The breechblock will now be able to move forward about another 1/2". Again, push rearward on the bolt head, depressing the breechblock back into the receiver about 1/4". With your right hand, reach in with a finger and push on the breechblock lever found on the bottom side of the breech block (See Figure 13). The breechblock lever serves to retain the breechblock in the receiver.

SPECIAL NOTE: It is possible to remove the breechblock first before removing the trigger group. You will need to simultaneously push rearward 1/4" on the breechblock and "reach" in through the opening at the front of the carrier to depress the breechblock lever, using the eraser end of a pencil, a small wood dowel, a screwdriver, or other similar object.)

FIGURE 14

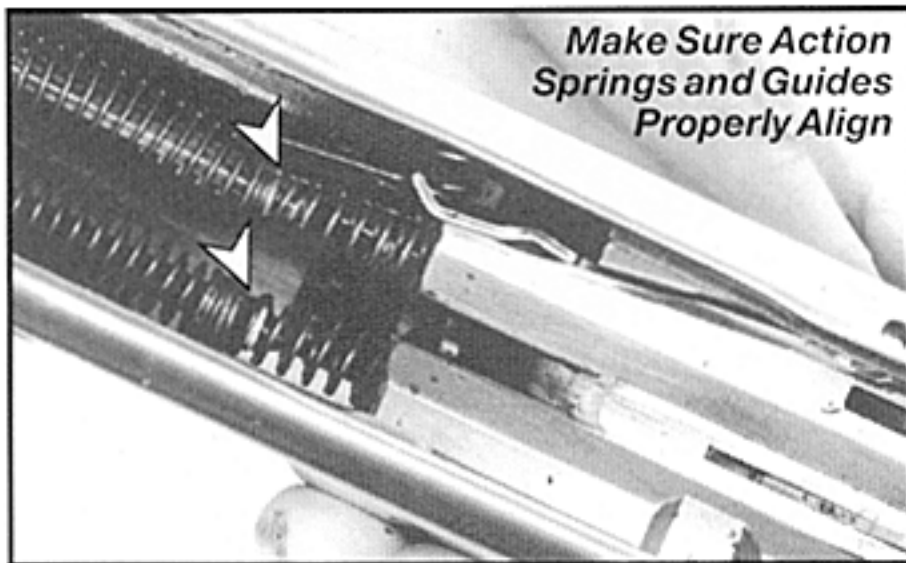

3. With the breechblock lever pressed, remove the breechblock, forward, out of the front of the receiver. The action springs will stay attached to the breechblock, projecting from the rear. The breechblock is now fully removed.

DO NOT DISASSEMBLE THE BREECHBLOCK BEYOND THIS POINT.

on the breechblock must fit in the receiver tracks. Make sure the front action springs fit over the ends of the action spring guides (See Figure 14). Push the breechblock in far enough so that the breechblock lever engages, holding the breechblock in the receiver. Simultaneously push back on the breechblock while depressing the breechblock release button until the notch in the ejection port lines up with the operating handle recess on the breechblock. Make sure that the action springs are compressed inside the recesses in the breechblock, and that the ends of the action spring guides start into the recesses in the breechblock without kinking the front action springs.

FIGURE 15



Reassembly:

Trigger Group and Breechblock

REINSTALLING THE BREECHBLOCK ASSEMBLY —

1. Insert the breechblock into the receiver opening, action springs first. The guides

2. Insert the operating handle into the recess (Refer to Figure 12-B). The breechblock is now installed.

REINSTALLING THE TRIGGER GROUP —

1. Reinsert the trigger group into the bottom of the receiver, moving it rearward to assure correct location of the rear pins into the holes in the receiver. Then start at the back and hinge the trigger guard forward (See Figure 15).
2. Line up the hole in the trigger guard with the holes on each side of the receiver. Insert the trigger guard retaining nut completely through the receiver. Start the retaining screw with your fingers and tighten using two screwdrivers, one for each slotted head on each side of the receiver.

Three-Shot Magazine Adapter

The A-500G shotgun is delivered with the three-shot magazine adapter installed in the magazine, limiting magazine capacity to two shells — allowing three shots total in compliance with federal migratory bird regulations. If you do not wish to be limited to three shots — when it is not required by law — you can remove or reinstall the three-shot adapter (plug) as follows:

ALWAYS WEAR PROTECTIVE SAFETY GLASSES DURING THIS OPERATION.

1. Unscrew the forearm cap and remove the forearm, **BARREL**, gas piston, sleeve bar assembly, and return spring from the gun as explained under “Disassembly of Barrel and Forearm Assembly” on page 18.

are it removing the three-shot adapter OR insert four 2 3/4" shells (or three 3-inch magnums) if the three-shot adapter was removed previously and you are it reinstalling it. Position an additional shells as if you were going to insert it into the magazine (it will stop only partially inserted because of the full magazine).

5. Apply steady, hard pressure on the shell, pushing all the shells forward in the magazine until the magazine spring retainer is dislodged from its compressed fitting at the end of the magazine (See Figure 16). You will feel forward movement of the shells in the magazine when it is dislodged.

IF IT WILL NOT DISLODGE WITH STEADY PRESSURE you may have to work the last shell in and out to increase

UNDER NO CIRCUMSTANCES SHOULD YOU PERFORM THE FOLLOWING PROCEDURES WITH THE BARREL ATTACHED.

2. Reinstall the magazine cap on the magazine tube approximately one turn, engaging at least **ONE FULL TURN OF THREADS** solidly.
3. Release the breechblock forward slowly by pressing the breechblock release button and slowly allowing the breechblock to travel forward. Do this by pressing the button with one hand and offering resistance on the operating handle with the other hand, gently easing it forward to the fully forward position.
4. Pull back approximately 1/4" of an inch on the operating handle. With your other hand: insert two 2 3/4" (or two 3-inch magnum shells) into the magazine if you

FIGURE 16



force on the shells in the magazine. If this also fails to dislodge the magazine spring retainer, place another shell behind the one partially inserted and apply increased pressure with the palm of your hand, or strike the back of the last shell with the palm of your hand until

FIGURE 17

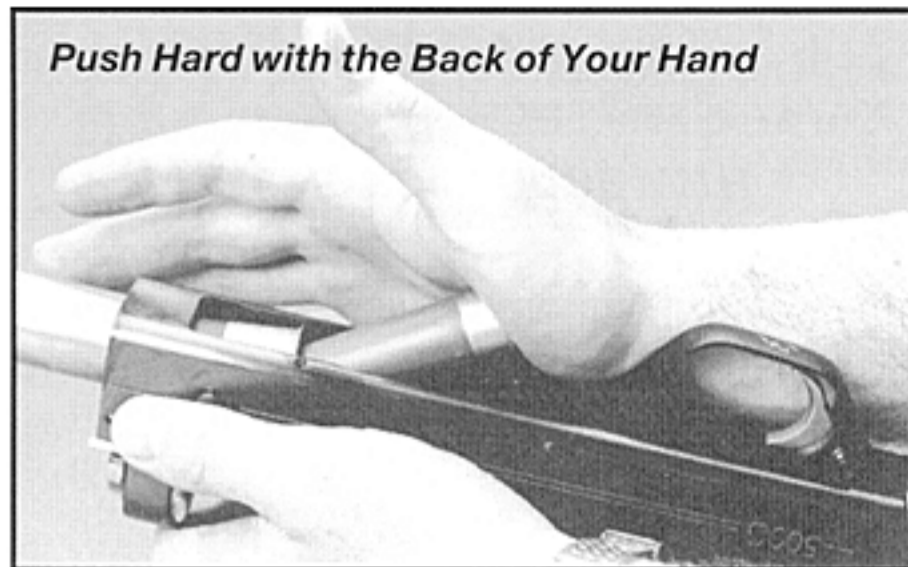

the retainer is dislodged (See Figure 17).

DO NOT USE ANY OTHER OBJECT THAN THE PALM OF YOUR HAND TO APPLY PRESSURE TO THE LAST SHELL.

6. With the retainer dislodged, **IMMEDIATELY REMOVE THE SHELLS FROM THE MAGAZINE. DO NOT UN-**

FIGURE 18

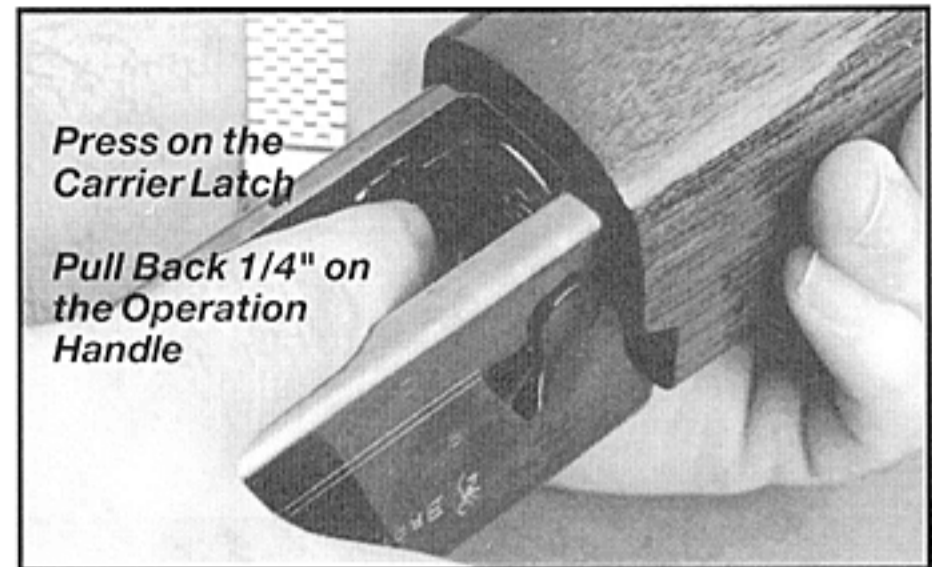

SCREW THE MAGAZINE CAP WITH SHELLS IN THE MAGAZINE.

Remove the shells as follows: first, hold the operating handle back approximately 1/4". Then release the shells from the magazine by reaching inside the loading port and simultaneously pressing in on the bottom of the carrier and pressing

FIGURE 19

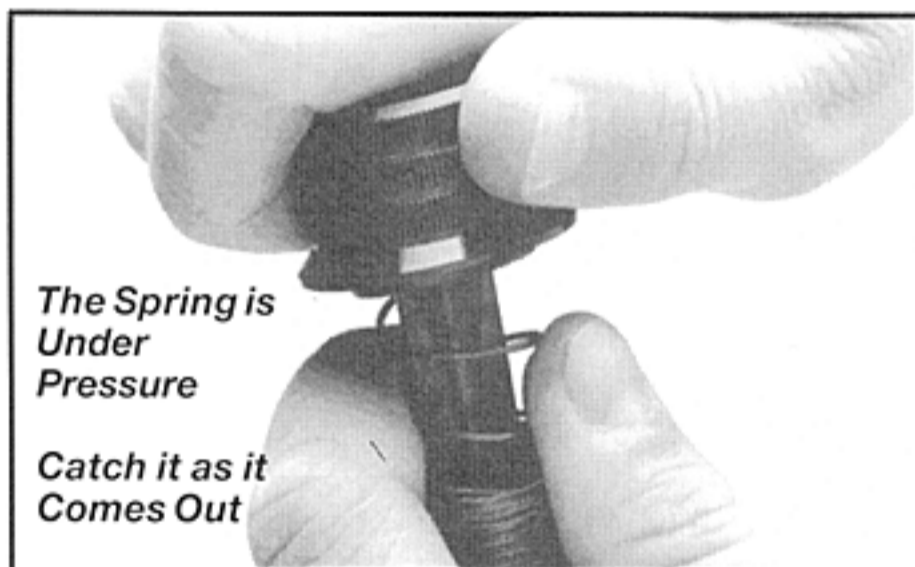

the carrier latch with your finger (See Figure 18). Release and remove one shell at a time from the magazine.

IMMEDIATELY PUT ALL THE SHELLS AWAY IN YOUR AMMUNITION STORAGE AREA—AWAY FROM YOUR A-500G AND OTHER GUNS.

7. Carefully unscrew the magazine cap from the magazine.

CAUTION: THE MAGAZINE SPRING IS UNDER TENSION AND WILL FORCE OUT THE RETAINER, THREE SHOT ADAPTER, AND THE SPRING ITSELF UNLESS CARE IS TAKEN.

Slowly lift the magazine cap off of the magazine. At the same time, catch the spring with your other hand as it begins to come out (See Figure 19). If already installed, the three shot adapter will be on top of the magazine spring.

8. Remove the spring and adapter, if present, from the magazine tube. Remove the magazine spring retainer from the inside of the magazine cap. The magazine follower can be removed by pointing the magazine tube downward and dumping it out.

REASSEMBLY WITH THE THREE-SHOT MAGAZINE ADAPTER INSTALLED.

To reassemble the magazine with the three-shot adapter installed, first, position the gun vertically, butt down. Then reinstall the magazine follower in the magazine tube, closed end first. Place the three-shot adapter inside one end of the magazine spring, small end first. Place the magazine spring retainer over the top of the adapter. Insert the other end of the magazine spring into the magazine tube and compress it into the magazine tube (See Figure 20). With hand pressure, seat the magazine spring retainer fully into the compression fitting on the end of the magazine tube.

REASSEMBLY WITHOUT THE THREE-SHOT MAGAZINE ADAPTER.

Reassembly of the magazine without the three-shot adapter is identical to reassembly *with* the three shot adapter, with one

compression fitting on the end of the magazine tube. Reassembly of the magazine, and removal/installation of the three-shot magazine adapter is now completed. To prepare for replacing the barrel and forearm on your A-500G, pull the operating handle on the breech-block fully rearward, locking the breechblock back. You are now ready to reinstall the barrel/forearm assembly to the receiver as outlined in "Assembly of Barrel and Gas System Components" on page 18.

Invector Interchangeable Choke System

All A-500G shotgun barrels have been threaded to accept the Browning Standard Invector Interchangeable Choke System. You may confirm this by looking on the right side of your barrel where the specifications are inscribed, and where the choke markings are normally located. The word **INVECTOR** denotes that the barrels

FIGURE 20



exception: after inserting the magazine follower into the magazine tube, place the magazine spring retainer directly on the end of the magazine spring. Then insert the other end of the magazine spring into the magazine tube and compress it into the magazine tube. With hand pressure, seat the magazine spring retainer fully into the

are threaded. The degree of choke tube is indicated twice on each choke tube: Inscribed on the side of the tube, and indicated with a "notch" code on the top rim of the tube. Invector Choke Tubes are made with tempered steel and are fully compatible with all **FACTORY AMMUNITION** (loaded in compliance with SAAMI specifications) including Magnum lead and steel shot loads and rifled slug loads.

DO NOT FIRE THIS SHOTGUN WITHOUT HAVING AN INVECTOR CHOKE TUBE INSTALLED.

Permanent damage may result to the threads.

DO NOT USE BROWNING INVECTOR CHOKE TUBES IN ANY SHOTGUN BARRELS NOT SUPPLIED BY BROWNING. ALSO, DO NOT USE ANY OTHER CHOKING DEVICE IN ANY SHOTGUN BARREL SUPPLIED BY BROWNING. USE ONLY CHOKE TUBES MARKED INVECTOR.

CAUTION: WHENEVER HANDLING ANY SHOTGUN FOR THE PURPOSE OF REMOVING OR INSTALLING A CHOKING DEVICE, MAKE ABSOLUTELY CERTAIN THE GUN IS FULLY UNLOADED, AND THE BOLT OR BREECH IS LOCKED OPEN! NEVER ATTEMPT TO REMOVE OR INSTALL A SHOTGUN CHOKING DEVICE ON A LOADED FIREARM!

TUBE REMOVAL—

1. **UNLOAD YOUR A-500G FULLY, INSPECT THE CHAMBER, FEED MECHANISM AND MAGAZINE TO MAKE SURE THEY DO NOT CONTAIN ANY SHELLS.**
2. Open the action, locking it rearward, and place the "safety" in the "on safe" position.
3. Use the Invector wrench to loosen the tube, turning it counterclockwise. Fingertwist the tube the rest of the way out of the barrel.

THE INVECTOR CHOKE TUBE SHOULD BE PERIODICALLY CHECKED TO ASSURE THAT IT IS TIGHT AND FIRMLY SEATED. BEFORE CHECKING, FOLLOW THE SAFETY GUIDELINES OUTLINED ABOVE.

Replacement and additional tubes and wrenches are available from your Browning dealer, or by writing to the

**Browning Consumer Department, Route 1,
Morgan, Utah 84050. (801) 876-2711.**

**Canadian customers please call or write to
Browning Canada Sports Ltd./Ltee,
3167 De Miniac, St. Laurent, Canada H4S 1W6.
(514) 333-7261.**

INVECTOR CHOKE TUBE CODE —

To identify individual Invector tubes, refer to the abbreviated indications on the side of the tube, or use the identification mark(s) located on the top rim of each tube (See Figure 21).

TUBE INSTALLATION—

1. **UNLOAD YOUR A-500G FULLY. INSPECT THE CHAMBER, FEED MECHANISM AND MAGAZINE TO MAKE SURE THEY DO NOT CONTAIN ANY SHELLS.**
2. Open the action locking it rearward and place the "safety" in the "on safe" position.
3. Before installing a tube, check the internal choke tube threads in the muzzle, as well as the threads on the Invector choke tube to be sure they are clean. Lightly oil the threads with an oil like Browning Oil.
4. Using your fingers, screw the appropriate tube into the muzzle end of the barrel, tapered end first, notched end outward. When it becomes finger-tight, use the Invector choke wrench to firmly seat the tube.

INVECTOR TUBE SELECTION

To help you choose the correct choke tube for each hunting situation, all Browning Invector choke tubes are inscribed on the side with the patterns they produce with both lead and steel shot. Each Invector tube also has notches in the top rim of the tube. These notches are a code to allow you to determine the choke designation while the tube is installed. Rim notches refer specifically to lead shot. You will need to use the chart below to cross-reference from lead to steel, and determine the appropriate tubes for your ammunition and hunting/shooting situation.

Several tubes are supplied with your Browning shotgun. The tubes listed are also available as accessories. Remember, Invector-Plus and standard Invector tubes are not interchangeable. Invector-Plus tubes

FIGURE 21

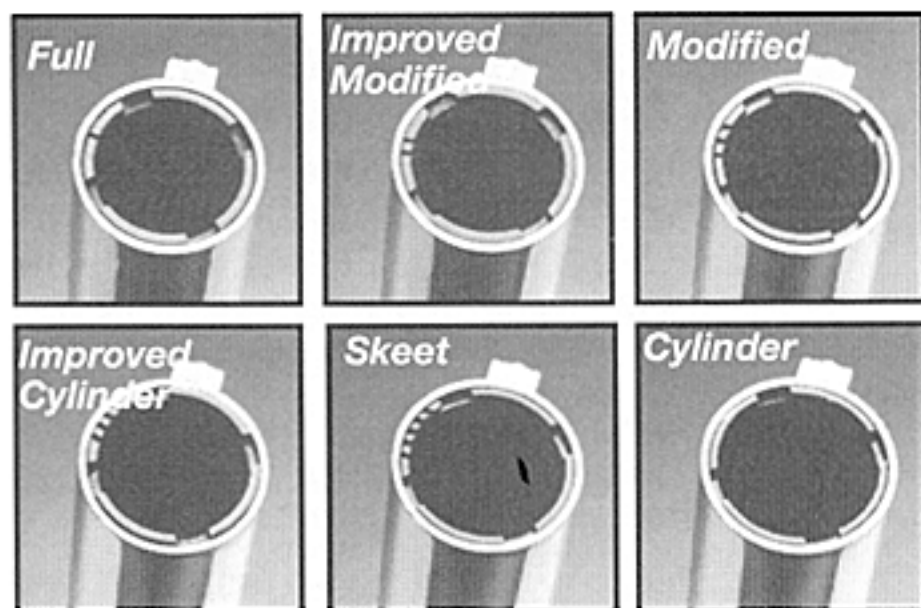

are for Browning guns with back-bored barrels and are not for use on your A-500G. Before removing/installing tubes, or reading the rim notch code, make sure your shotgun is fully unloaded.

Use of Extra Barrels

On all Browning A-500G shotguns, barrels of the same gauge are completely interchangeable, and no special fitting is required. Thus, by merely buying another barrel of a different length, or for a different purpose (such as a Buck Special barrel), and using the appropriate Invector choke tube, you have acquired the utility of another gun at a fraction of the cost of a new gun; a duck gun becomes a fine upland game gun, a pheasant gun becomes a rifled slug deer gun.

Sight Adjustment for Buck Special Barrels

Buck Special barrels are equipped with a precision rear sight which is screw adjustable for both horizontal and vertical correction.

Rim Notches	Pattern With Lead Shot	Pattern With Steel Shot
I	Full	*
II	Imp. Modified	Full***
III	Modified	Full***
IIII	Imp. Cylinder	Modified
IIII	Skeet	Imp. Cylinder**
No Notches	Cylinder	Imp. Cylinder***
Knurled Ext.	X-Full Special	**

**Not for use with steel shot. Using an over-tight choke constriction with steel shot will result in an ineffective, "blown" pattern.*

***Extra Full Special with knurled rim and no rim code. Do not use with steel shot.*

****When more than one choke designation is listed for a given steel shot pattern, use the more open choke listed for high velocity, larger shot size steel shot loads.*

CAUTION: DO NOT USE STANDARD INVECTOR CHOKE TUBES IN BARRELS MARKED INVECTOR-PLUS. DO NOT USE INVECTOR-PLUS CHOKE TUBES IN BARRELS MARKED INVECTOR. FAILURE TO FOLLOW ALL OF THE ABOVE WARNINGS CAN DAMAGE YOUR GUN AND CAUSE INJURY TO YOURSELF AND OTHERS.

WINDAGE ADJUSTMENT —

To move point of impact to the **RIGHT**, loosen the small screw on the right side of the sight. Then tighten the small screw on the left side of the sight. To move point of impact to the **LEFT** loosen the small screw on the left side of the sight and tighten the screw on the right side. This is a process of trial and error. Make small adjustments then check the point of impact.

VERTICAL ADJUSTMENT —

Adjustment of the sight is controlled by the screw located on top of the sight. To **RAISE** the point of impact, turn the screw in a counterclockwise direction. To **LOWER** the point of impact, turn the screw in a clockwise direction. Vertical adjustment is also a process of trial and error.

Cleaning and Maintenance Suggestions

You should clean your A-500G whenever it becomes excessively dirty — and perform a thorough cleaning at least once a year. The barrel should be cleaned, and the action wiped clean and oiled after every day of shooting. The gas system should require only occasional cleaning. If a malfunction occurs, perform a thorough cleaning, to see if it solves the problem, before seeking the services of a Browning Recommended Service Center, the Browning Service Facility in Arnold, Missouri, or a competent gunsmith.

Normal maintenance can be accomplished with the barrel still attached to the receiver (oiling and wiping down). More careful cleaning requires removal of only the barrel from the receiver (cleaning the barrel), and the removal of several gas system

placed on the end of the action bar where it slides along the track in the receiver (See Figure 22). This will help to relieve friction and ensure smooth operation.

Also, lightly lubricate the breechblock, rotary bolt and spring guides. If the gun has been exposed to much dust, dirt, mud or water, the principal working parts including the gas system, should be wiped clean and lubricated with a light film of oil. Browning Oil is recommended.

DO NOT POUR LARGE QUANTITIES OF OIL INTO THE ACTION. A LARGE EXCESS OF OIL WILL RUN BACK INTO THE WOOD OF THE STOCK AND CAUSE SOFTENING OF THE WOOD, WITH CONSEQUENTIAL LOOSENING OF THE STOCK.

CLEANING THE BARREL —

The correct procedure for cleaning your A-500 shotgun is as follows:

FIGURE 22

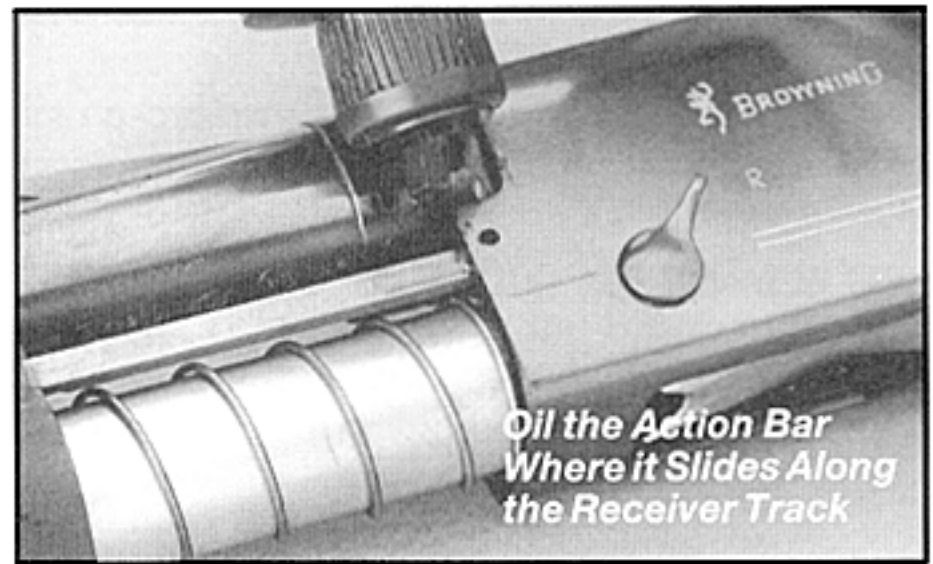

components. A complete cleaning requires removal of the breechblock and trigger group.

PERIODIC OILING —

Ordinary good judgment will indicate that the metal parts of the gun should receive a light film of oil after the gun has been exposed to weather or handling.

Occasionally, a small drop of oil may be

1. **BE CERTAIN YOUR SHOTGUNS MAGAZINE, FEED MECHANISM AND CHAMBER ARE UNLOADED. PLACE THE "SAFETY" IN THE "ON SAFE" POSITION AND LOCK THE BOLT TO THE REAR. ALWAYS WEAR PROTECTIVE SAFETY GLASSES DURING ALL DISASSEMBLY AND CLEANING PROCEDURES.**
2. Remove the barrel so that it can be cleaned from the breech end (See "Disassembly" on page 18).
3. Using a shotgun cleaning rod with tip and patch large enough for a snug fit in the bore, insert the rod and patch in the breech end of the barrel and run back and forth through the bore several times. Remove and wipe the Invector tube, tube threads and barrel threads, and lightly oil.

4. Inspect the bore from both ends for leading by looking through bore toward light. Leading will appear as dull longitudinal streaks and is usually more predominant near the muzzle and just forward of the chamber.
5. A normal amount of leading can be expected with today's high velocity loads and improved wads but this is not serious. If or when leading should become heavy, it can be removed with a brass bore brush. Make sure a choke tube is installed. Spray the bore or the bore brush with a good powder solvent, and scrub the bore until leading is removed. To prevent brass bristles from breaking off, the brush should be pushed completely through the bore before being withdrawn.
6. After leading has been removed, the bore should be wiped dry with a clean patch, and then a lightly oiled patch run through it for preservation.

2. To clean the gas system, first spray the gas piston with a good powder solvent and brush it thoroughly to remove any deposits (an old toothbrush is ideal for this). Spray into the gap between the inner and outer portions of the piston.
3. Clean the gas regulation valve system (it is located inside the barrel ring guide/gas cylinder) by spraying it with a aerosol Browning Oil or a good powder solvent, and brushing any deposits free (See Figure 23). **NEVER** use a steel brush on any of the gas components.

Pay special attention to the gas pressure vents (two large holes on opposite sides of the barrel ring guide/gas cylinder), and the two gas ports (seen inside the gas cylinder at the top, when viewed from the breech end). Spray again to wash away the loosened deposits and wipe clean. A **NONFLAMMABLE** sol-

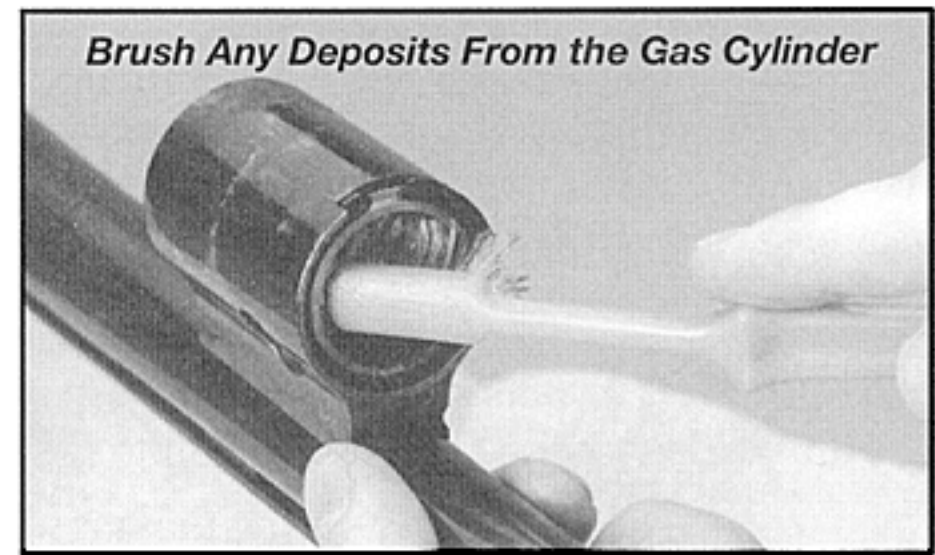
FIGURE 23

CLEANING THE GAS SYSTEM —

1. Remove the gas piston, sleeve bar assembly and return spring from the magazine tube. Spray the tube with Browning oil (or a good quality powder solvent) and wipe clean. Remove the return spring from the sleeve and wipe clean. Spray the inside of the sleeve and wipe off of any buildup.

vent bath can be used to immerse the parts, but it is not necessary.

CAUTION: NEVER DISASSEMBLE THE GAS CYLINDER.

The parts are under spring tension and require special tools for removal. It is not necessary to remove the gas pressure regulation valve assembly (from its location inside of the barrel ring guide/gas cylinder) to perform cleaning. You should note that all gas system parts on the A-500G have been given extra protection against corrosion: the magazine tube is chrome-plated, and all other gas system parts, including the piston, springs, barrel guide ring and gas regulation valve, are made from stainless steel.

4. Complete the cleaning of the gas system by applying a very light film of Browning Oil to all parts for protection and lubrication.

CLEANING THE ACTION AND TRIGGER GROUP —

1. When the action becomes excessively dirty, remove the trigger group and breechblock assembly from the receiver as explained under "Full Disassembly" on page 28. Clean with an oil such as Browning Oil or a gun solvent as necessary, using an old toothbrush to loosen any caked-on grime. Wipe the receiver cavity clean. Lightly oil the cavity (aerosol Browning Oil is ideal) and wipe it dry. No further disassembly is required for cleaning.
2. Reassemble the trigger group, breechblock, gas system and the barrel to the receiver as explained previously. Then wipe all exposed metal surfaces with an oiled cloth making sure to wipe your A-500G clean of all finger marks where moisture will accumulate.

Service or Repair

If your firearm should require service or repairs, we suggest you first contact a local recommended Browning Firearms Service Center. Contact your Browning sporting goods dealer or call our Service Department for the address of the Service Center nearest you. Otherwise, you may send your firearm directly to our own Service Department. For technical questions about your firearm or service call our Service Department.

Browning Service Department
3005 Arnold Tenbrook Road
Arnold, Missouri 63010-9406
Phone: 1-800-322-4626

Canadian Customers call or write:

Browning Canada Sports Ltd./Ltee,
5617 Chemin St-Francois
St-Laurent, Quebec H4S 1W6
Phone: (514) 333-7261

3. The barrel and action should be inspected to assure that all cleaning patches have been removed and not inadvertently left in the barrel or action.
4. The wood surfaces can also be wiped with Browning Oil or they can be polished with any quality furniture wax (but not both).

DO NOT TAKE YOUR GUN'S ACTION APART BEYOND THE EXTENT EXPLAINED IN THIS MANUAL.

This is a specialized, finely fitted mechanism, and you may mar it for life by an attempt to disassemble the inner mechanism assemblies. Do not disassemble the breechblock, gas system or trigger group more than described. If further disassembly is required, take your gun to a Browning Recommended Service Center or a competent gunsmith.

When returning your firearm for servicing, you *must* do the following:

- a. Be sure it is completely unloaded.
- b. Package it securely in a cardboard container.
- c. Enclose a letter with your firearm that clearly describes the trouble experienced and the repairs or alterations desired.
- d. If convenient, send a copy of the letter to us separately.
- e. Never return ammunition with your firearm. It is against postal and most commerce regulations.

If you have any questions about this manual or about any other Browning products, call or write our Consumer Information Department:

Browning Consumer Information
Morgan, Utah 84050
Phone: (801) 876-2711