



FNH USA
FNP-45
TACTICAL

AUTOLOADING PISTOL
OWNER'S MANUAL

Important operating instructions for:

FNH USA FNP-45 TACTICAL AUTOLOADING PISTOLS

If you have any questions or comments regarding your new firearm, please contact us.

FNH USA, LLC, (703) 288-1292, extension 122 or 104, www.fnhusa.com

Please use the space below to record information about your new firearm.

Model _____

Serial Number _____

Purchased From _____

Date of Purchase _____

CONTENTS PAGE

1. Foreword.....	2	16. Unloading.....	29
2. Contents of the Storage Case	3	16.1. Unloading the Pistol	30
3. Safety and Warranty Notes	4	16.2. Unloading the Magazine.....	30
4. Firearm Safety Information.....	5	17. Cleaning and Lubrication.....	31
5. Nomenclature.....	12	17.1. Disassembling the Pistol.....	32
6. Description and Operation.....	12	17.2. Cleaning and Lubrication	34
6.1. Description	12	17.3. Assembling the Pistol	36
6.2. Operation.....	14	17.4. Disassembling the Magazine.....	37
7. Initial Cleaning	15	17.5. Cleaning and Lubrication of the Magazine	38
8. Operation of the Ambidextrous “Safety”/Decocking Lever	15	17.6. Assembling the Magazine	38
8.1. Manual “Safety” Function	17	18. Taking Care of the Pistol	39
8.2. Decocking Function	18	19. Accessories	40
9. Ambidextrous Slide Stop.....	19	19.1. Interchangeable Backstraps	40
10. Loaded Chamber Indicator	20	19.2. Accessory Rail	41
11. Before Using the Pistol	20	20. Combat Sights.....	41
12. Carrying Your Pistol	21	21. Mounting Electronic Sights	41
13. Ammunition	22	21.1. Docter and Trijicon Electronic Sights.....	42
14. Loading	22	21.2. C-More Systems and FNH USA Electronic Sights	43
14.1. Magazine Capacity	22	22. Threaded Muzzle	44
14.2. Loading the Magazine	24	23. Troubleshooting.....	44
14.3. Loading the Pistol	25	24. Warranty, Service and Technical Questions	45
15. Firing	26	25. Service Policy	46
15.1. Firing the Pistol.....	26	26. Technical Specifications.....	47
15.2. Reloading During Firing.....	28		

THIS OWNER'S MANUAL HAS BEEN WRITTEN EXCLUSIVELY FOR THE FNH USA FNP-45 TACTICAL PISTOL.

Warnings and instructions are different for each type of pistol.

If your FNH USA pistol has inscriptions other than “FNP-45 Tactical” and “45 ACP” on its front left side or if the external appearance of the pistol does not correspond to the illustrations of this owner's manual, you must contact your dealer, departmental armorer or contact FNH USA immediately to obtain the free owner's manual that has been written specifically for your pistol.

1. FOREWORD

We are pleased that you have chosen an FNH USA FNP-45 Tactical autoloading pistol. Based on sound firearm design, the FNP-45 Tactical stands for the highest level of reliability, consistent accuracy, functional design and provides the operating precision and safety expected from an FNH USA firearm.

The FNP-45 Tactical is a recoil-operated, double/single-action operated autoloading pistol with an ambidextrous “safety”/decocking lever. With the chamber and the magazine loaded, the pistol will fire a single cartridge each time the trigger is pulled until the magazine and the chamber are empty. If the hammer is not in the cocked position, the first shot will be double-action with a heavier and longer trigger pull, with subsequent shots fired single-action with a lighter and shorter trigger pull. Recoil force causes the slide to move rearward and eject the empty case out of the ejection port and cock the hammer. The slide of this pistol will stay open after the last cartridge has been fired.

Simple and durable in design, the pistol is very easy to maintain. With a reasonable amount of care, your FNP-45 Tactical should give you many years of dependable service. In order to take maximum advantage of the many features of your FNP-45 Tactical, regularly review this owner's manual.

Please contact FNH USA if you have any observations or questions regarding the performance or the operation of your pistol.

Thank you.

2. CONTENTS OF THE STORAGE CASE

The pistol and its accessories are shipped in a soft fabric storage case. The contents of the storage case include:

- Pistol
- Locking device and two keys (Use the locking device to assist in the safe storage and transport the pistol. Always keep the keys at a safe place.)
- Three 15-round magazines (Three 10-round magazines when required by law.)
- Four interchangeable backstraps
- Two mounting plates and installation hardware for optional electronic sights
- Owner's manual

3. SAFETY AND WARRANTY NOTES

⚠ DANGER

LIKE ALL FIREARMS, IF HANDLED IN A CARELESS OR RECKLESS MANNER THE FNP-45 CAN BE VERY DANGEROUS. FAILURE TO FOLLOW THE INFORMATION IN THIS OWNER'S MANUAL COULD RESULT IN SERIOUS INJURY OR DEATH.

For that reason, this firearm has been sold under the express understanding that FNH USA declines any responsibility and invalidates any guarantee and liability claims for incidental or consequential damages, injuries, loss of use of property, commercial loss, loss of earnings and profits, resulting in whole or partly from:

- the use of reloaded ammunition
- a discharge with criminal intent or through negligence
- improper or careless handling
- unauthorized servicing
- the modification or alteration of the basic firearm design
- the use of non-original parts
- the modification or alteration of the “safety” devices
- the use of incorrect “arms and ammunition” combinations
- the use of defective or unsafe ammunition
- inadequate care of the firearm (e.g. corrosion, damage.)
- disregard of malfunctions
- resale in contradiction to legislation
- other circumstances beyond our direct and immediate control

NOTICE! FNH USA RESERVES THE RIGHT TO REFUSE SERVICING A FIREARM WHICH HAS BEEN MODIFIED BY REMOVAL OF METAL FROM THE BARREL, MODIFICATIONS OF THE FIRING MECHANISM AND/OR OTHER PARTS, AND WILL, IN SUCH A CASE, ALWAYS RECOMMEND RESTORING THE FIREARM TO ITS ORIGINAL SPECIFICATIONS. PARTS AND LABOR REQUIRED FOR SUCH A RESTORATION ARE PAYABLE BY THE OWNER OF THE FIREARM.

4. FIREARM SAFETY INFORMATION

⚠ WARNING

FAILURE TO FOLLOW ANY OF THE FOLLOWING WARNINGS COULD RESULT IN SERIOUS INJURY OR DEATH.

As a firearm owner, you accept a set of demanding responsibilities. How seriously you take these responsibilities can be the difference between life and death.

There is no excuse for careless or abusive handling of any firearm. At all times handle this firearm and all other firearms with intense respect for their power and potential danger.

Please read and understand all of the cautions, warnings, notices, proper handling procedures and instructions outlined in this owner's manual before using your new firearm.

1 ALWAYS KEEP THE MUZZLE OF YOUR FIREARM POINTED IN A SAFE DIRECTION EVEN THOUGH YOU ARE CERTAIN IT IS UNLOADED.

Never point any firearm at anything you do not intend to shoot. Be extremely alert and aware of all persons and property within the range of your ammunition.

2 NEVER RELY TOTALLY ON YOUR FIREARM'S MECHANICAL “SAFETY” DEVICES. LIKE ANY MECHANICAL DEVICE, A “SAFETY” CAN SOMETIMES FAIL; IT CAN BE JARRED OR INADVERTENTLY MANIPULATED INTO AN UNSAFE CONDITION.

The word “safety” describes a firearm's trigger block mechanism, sear block mechanism, hammer block mechanism or firing pin block mechanism. Mechanical “safeties” are designed to place your firearm in a safer status, and no guarantee can be made that the firearm will not fire even if the “safety” is in the on safe position. Mechanical “safeties” merely aid safe gun handling and are no excuse for pointing your firearm's muzzle in an unsafe direction. See Section 8 for instructions on the operation of this firearm's “safety.”

Remember, safe gun handling does not stop with your firearm's mechanical "safety" devices, it starts there. Always treat this firearm with the respect due a loaded, ready-to-fire firearm.

Some firearms do not have a mechanical safety. Many target firearms, lever-action firearms and pistols do not have manual "safety" mechanisms. Therefore it is critical to read and understand the owner's manual for every firearm which explains the safe operation of the firearm.

While it is a good idea to "test" your firearm's mechanical "safety" periodically for proper function, never test the "safety" while your firearm is loaded or pointed in an unsafe direction.

3 WHENEVER YOU HANDLE ANY FIREARM, OR HAND IT TO SOMEONE, ALWAYS OPEN THE ACTION IMMEDIATELY AND VISUALLY CHECK THE FIREARM'S CHAMBER AND MAGAZINE TO MAKE CERTAIN THAT THE FIREARM IS COMPLETELY UNLOADED.

Completely unload your firearm as described in Section 16.1. Make certain the firearm does not inadvertently contain any ammunition. Remember, merely removing the magazine does not mean the chamber is unloaded. Always keep the chamber empty and the "safety" in the on safe position unless shooting is imminent.

4 ALWAYS WEAR EYE AND HEARING PROTECTION WHEN SHOOTING.

Unprotected, repeated exposure to gunfire can cause hearing damage. Wear ear protectors (shooting earplugs or muffs) to guard against such damage.

Wear shooting glasses to protect your eyes from flying particles. Allow proper distance (eye relief) between a scope and your eye when firing a scoped pistol, rifle or shotgun. Do not use unorthodox shooting methods that could cause the rearward travel of the slide or bolt of a firearm to contact your eyes, face or hands. Always keep a safe

distance between the muzzle of your firearm and any persons nearby, as muzzle blast, debris and ejecting shells could inflict serious injury.

Always wear eye protection when disassembling and cleaning your pistol to prevent the possibility of springs, spring-tensioned parts, solvents or other agents from contacting your eyes.

5 KEEP ALL FIREARMS UNLOADED DURING TRANSPORT, EVEN WHEN STORED IN A HOLSTER, GUN CASE, SCABBARD OR OTHER CONTAINER.

For law enforcement and military personnel, refer to the procedures of your department on carrying a loaded firearm.

6 DROPPING OR JARRING A LOADED FIREARM CAN CAUSE AN ACCIDENTAL DISCHARGE.

This can occur even with the "safety" in the on safe position or the hammer in the decocked position. Be extremely careful while hunting or during any shooting activity, to avoid dropping any firearm.

7 SHOOTING FROM ELEVATED SURFACES IS DANGEROUS.

Doing so may increase the risk of mishandling a firearm. The following rules should always be observed. Always make certain that the surface being used is safe and stable. Always make certain that your firearm is unloaded when it is being taken up and down from the surface. Always make certain that your firearm is not dropped from the surface, or dropped while it is being taken up or down from the surface. Remember, a loaded firearm may discharge when dropped, even with the "safety" in the on safe position.

8 STORE YOUR FIREARM AND AMMUNITION SEPARATELY, WELL BEYOND THE REACH OF CHILDREN.

Take prudent safeguards to ensure your firearm does not become available to untrained, inexperienced or unwelcome hands. Store all firearms in secure, locked cases or a gun safe. Keep your firearm unloaded when not in use. At all times, comply with local and state laws.

For law enforcement and military personnel, refer to the procedures of your department on storing your firearm.

9 BEWARE OF BARREL OBSTRUCTIONS.

Mud, snow and an infinite variety of other objects may inadvertently lodge in a barrel bore. It only takes a small obstruction to cause dangerously increased pressures that can damage your firearm and cause serious injury to yourself and others.

BEFORE CHECKING FOR A BARREL OBSTRUCTION, BE CERTAIN YOUR FIREARM IS COMPLETELY UNLOADED, THERE IS NOT A LIVE CARTRIDGE IN THE CHAMBER AND THE “SAFETY” IS IN THE ON SAFE POSITION.

Completely unload the firearm as described in Section 16.1. After assuring yourself that the firearm is completely unloaded, open the breech or action and look through the barrel to be sure it is clear of obstructions. If an obstruction is seen, no matter how small it may be, clean the bore with a cleaning rod and patch as described in Section 17.2. of this owner’s manual.

10 BE ALERT TO THE SIGNS OF AMMUNITION MALFUNCTION. IF YOU DETECT AN OFF SOUND OR LIGHT RECOIL WHEN A CARTRIDGE IS FIRED, DO NOT LOAD ANOTHER CARTRIDGE INTO THE CHAMBER.

If your firearm fails to fire, keep the muzzle pointed in a safe direction for a minimum of 30 seconds. Carefully open the action and remove the cartridge from the chamber, and completely unload the firearm as described in Section 16.1. If the primer is indented, the defective cartridge should be disposed of in a way that cannot cause harm. If the primer is not indented, your firearm should be examined by a qualified gunsmith and the cause of the malfunction corrected before further use. Glance down the barrel to make sure that there are no obstructions in the barrel. If there is an obstruction, completely clear the barrel before loading and firing again. Failure to follow these instructions can cause extensive damage to your firearm and possible serious injury to yourself and others.

11 NEVER INSERT A CARTRIDGE OF THE INCORRECT CALIBER INTO ANY FIREARM.

The caliber of your firearm is marked on the slide and barrel. Store all cartridges of different calibers in completely separate and well-marked containers. Never store cartridges of mixed calibers in a common container or in your pockets. See Section 13 for more information on the correct ammunition for your firearm.

12 EXAMINE EVERY CARTRIDGE YOU PUT IN YOUR FIREARM.

We assume no responsibility for the use of unsafe or improper firearm and ammunition combinations or damage or injury caused by damaged ammunition. It is your responsibility to read and heed all warnings in this owner’s manual and on ammunition boxes. See Section 13 for more information on the correct ammunition for your firearm.

13 USE ONLY SAAMI APPROVED AMMUNITION.

The barrel and the slide of this pistol have been made with substantial safety margins over the pressures developed by established American commercial loads. Nevertheless, we can assume no liability for incidents which occur through the use of cartridges of nonstandard dimensions or which develop pressures in excess of commercially available ammunition which has been loaded in accordance with standards established by the Sporting Arms and Ammunition Manufacturers’ Institute (SAAMI).

14 MAKE SURE OF ADEQUATE VENTILATION IN THE AREA THAT YOU DISCHARGE A FIREARM. LEAD EXPOSURE CAN OCCUR FROM DISCHARGING FIREARMS IN POORLY VENTILATED AREAS, CLEANING FIREARMS OR HANDLING AMMUNITION.

Lead is a substance that has been known to cause birth defects, reproductive harm and other serious injury. Wash hands thoroughly after exposure to ammunition or after cleaning a firearm.

15 DO NOT SNAP THE FIRING PIN ON AN EMPTY CHAMBER: THE CHAMBER MAY NOT BE EMPTY!
Treat every pistol with the respect due a loaded pistol, even though you are certain the pistol is unloaded.

16 KEEP YOUR FINGERS AWAY FROM THE TRIGGER AT ALL TIMES UNTIL SHOOTING IS IMMINENT.

17 BE SURE OF YOUR TARGET AND BACKSTOP, PARTICULARLY DURING LOW LIGHT PERIODS.
Know the range of your ammunition. Never shoot at water or hard objects.

18 ALWAYS UNLOAD YOUR FIREARM'S CHAMBER BEFORE CROSSING A FENCE, CLIMBING A TREE, JUMPING A DITCH OR NEGOTIATING OTHER OBSTACLES.
Never place your firearm on or against a fence, tree, car or other similar object.

For law enforcement and military personnel, refer to the procedures of your department.

19 BE DEFENSIVE AND ON GUARD AGAINST UNSAFE GUN HANDLING AROUND YOU AND OTHERS.
Don't be timid when it comes to gun safety. If you observe other shooters violating any of these safety precautions, politely suggest safer handling practices.

20 BE CERTAIN YOUR FIREARM IS UNLOADED BEFORE CLEANING.
Because so many gun accidents occur when a firearm is being cleaned, special and extreme care should be taken to be sure your firearm is unloaded before disassembly, cleaning and reassembly. Keep ammunition away from the cleaning location. Never test the mechanical function of any firearm with live ammunition.

21 TEACH AND SUPERVISE FIREARMS SAFETY TO ALL MEMBERS OF YOUR FAMILY, ESPECIALLY TO CHILDREN AND NON-SHOOTERS.
Closely supervise newcomers to the shooting sports. Encourage enrollment in hunting and shooting safety courses.

22 NEVER DRINK ALCOHOLIC BEVERAGES OR TAKE ANY TYPE OF DRUGS BEFORE OR DURING SHOOTING.
Your vision, motor skills and judgment could be dangerously impaired, making your gun handling unsafe to you and to others.

23 READ AND HEED ALL WARNINGS IN THIS OWNER'S MANUAL, ON AMMUNITION BOXES AND WITH ALL ACCESSORIES THAT YOU INSTALL ON YOUR FIREARM.
It is your responsibility to secure the most up-to-date information on the safe handling procedures for your FNH USA firearm.

We assume no liability for incidents which occur when unsafe or improper pistol accessories or ammunition combinations are used.

24 PRACTICE PERIODIC MAINTENANCE, AVOID UNAUTHORIZED SERVICING.
Your firearm is a mechanical device which will not last forever, and as such, is subject to wear and requires periodic inspection, adjustment and service. FNH USA firearms should be serviced by our service facility in Arnold, Missouri.

We cannot assume any responsibility for injuries suffered or caused by unauthorized servicing, alterations or modifications of FNH USA firearms.

25 WE RESERVE THE RIGHT TO REFUSE SERVICE ON FIREARMS THAT HAVE BEEN ALTERED, ADDED TO OR SUBSTANTIALLY CHANGED.

Removal of metal from the barrel or modifications of the firing mechanism and/or operating parts may lead to a refusal of service on such firearms. We will charge the owner for parts and labor to return the firearm to original FNH USA specifications.

DO NOT, UNDER ANY CIRCUMSTANCES, ALTER THE TRIGGER, SAFETY OR OTHER PARTS OF THE FIRING MECHANISM OF THIS OR ANY OTHER FIREARM. FAILURE TO OBEY THIS WARNING MAY RESULT IN INJURY OR DEATH TO YOURSELF OR OTHERS.

BE CAREFUL!

5. NOMENCLATURE

In conventional gun terminology, the position and movement of parts are described as they occur with the firearm horizontal and in the normal firing position: the muzzle is forward or front, the pistol grip is rearward or rear, the trigger is downward or underneath, the sights are upward or on top. For general parts nomenclature refer to Figures 1 and 2.

Most of the illustrations in this owner's manual show the FNP-45 Tactical pistol with the curved back strap. If desired, the ergonomics of the pistol grip can be modified by replacing the back strap. For more information on replacing the backstrap refer to Section 19.1.

6. DESCRIPTION AND OPERATION

6.1. DESCRIPTION

The FNP-45 Tactical is an autoloading single- and double-action pistol that functions on the principle of recoil operation. The frame is constructed from a durable polymer and features replaceable slide rails that extend the service life of the pistol far beyond that of other polymer-framed pistols.

FIGURE 1

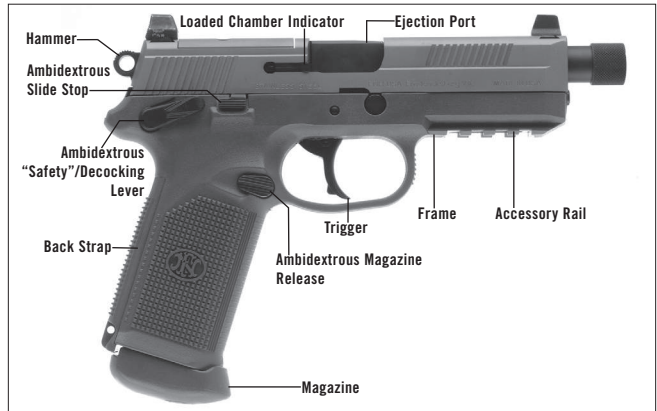

Right view of the pistol.

FIGURE 2



Left view of the pistol.

FIGURE 3



Hammer decocked for double-action firing

FIGURE 4



Hammer cocked for single-action firing

6.2. OPERATION

When the trigger is pulled, the hammer strikes the firing pin which, in turn, strikes the primer of the cartridge, resulting in the pistol firing. The recoil force causes the slide to be moved rearward. During the rearward movement of the slide, the empty cartridge case is ejected out of the ejection port. If there is a cartridge in the magazine, the slide then returns forward by the force of the recoil spring, picks up a cartridge from the magazine and loads it into the chamber, ready to be fired. If there is not a cartridge in the magazine during this movement, the ambidextrous slide stop will engage and the slide remains open.

With the chamber and the magazine loaded, the pistol will fire a single shot each time the trigger is pulled until the magazine and the chamber are empty. The slide of this pistol is designed to stay open after the last cartridge has been fired.

If the hammer is in the decock position, the first shot will be double-action with a heavier and longer trigger pull (Figure 3). If, after firing a double-action shot, the hammer is not decocked by the left or right ambidextrous decocking lever (Section 8.2), the following shots will be single-action with a lighter and shorter trigger pull (Figure 4).

7. INITIAL CLEANING

Various exposed metal parts of your pistol have been coated at the factory with a rust preventative lubricant. Before using your pistol, clean the rust preventative lubricant from the inside of the barrel, slide and the action/chamber areas with a quality gun oil as explained in Section 17.2. If your pistol is to be stored, it is acceptable to leave the rust preventative lubricant on the pistol and keep it in its original packaging. Never fire the pistol upon purchase without cleaning it first. If the pistol contains hardened grease or other substances that you cannot remove, have the pistol checked by your dealer or departmental armorer.

For law enforcement and military personnel, refer to the procedures of your department.

8. OPERATION OF THE AMBIDEXTRIOUS “SAFETY”/DECOCKING LEVER

⚠️ WARNING

ALWAYS KEEP THE MUZZLE POINTED IN A SAFE DIRECTION EVEN IF YOU ARE CERTAIN THE PISTOL IS UNLOADED. ALWAYS KEEP THE HAMMER IN THE DECOCKED POSITION, THE “SAFETY” IN THE ON SAFE POSITION AND YOUR FINGERS AWAY FROM THE TRIGGER UNLESS SHOOTING IS IMMINENT. A FAILURE OF A “SAFETY” DEVICE CAN OCCUR AT ANY TIME, ESPECIALLY WHEN THE PISTOL IS SUBJECTED TO EXTREME FORCES OR CONDITIONS NOT NORMALLY ENCOUNTERED UNDER NORMAL SHOOTING CONDITIONS.

CHAMBER A CARTRIDGE ONLY WHEN SHOOTING IS IMMINENT. WHEN YOU PLACE A CARTRIDGE IN THE CHAMBER, IMMEDIATELY PLACE THE HAMMER IN THE DECOCKED POSITION USING THE AMBIDEXTRIOUS “SAFETY”/DECOCKING LEVER AND PLACE THE “SAFETY” IN THE ON SAFE POSITION.

ALWAYS TRANSPORT AND STORE YOUR PISTOL WITH THE CHAMBER AND MAGAZINE COMPLETELY UNLOADED AND WITH THE HAMMER IN THE DECOCKED POSITION AND WITH THE “SAFETY” IN THE ON SAFE POSITION.

NEVER RELY TOTALLY ON THE “SAFETY” MECHANISMS OF YOUR PISTOL. LIKE ANY OTHER MECHANICAL DEVICE, IT COULD FAIL; IT CAN BE JARRED OR INADVERTENTLY MANIPULATED INTO AN UNSAFE CONDITION.

FAILURE TO FOLLOW THESE WARNINGS COULD RESULT IN SERIOUS INJURY OR DEATH.

FNP-45 Tactical pistols feature an ambidextrous decocking/“safety” lever located on both sides of the rear of the frame. It can be conveniently operated by a left- or right-handed shooter. The levers are serrated for positive manipulation. The decocking/“safety” lever has two functions, operating the manual “safety” and decocking the hammer.

If you do not intend to fire immediately, and in order to obtain the safest condition, the pistol should be set for double-action shooting which means that the hammer should be decocked using the ambidextrous “safety”/decocking lever. To decock the hammer point the pistol in a safe direction and push down on the left or right ambidextrous “safety”/decocking lever with your thumb as described in Section 8.2. (Figure 5). The hammer will move to the decocked position where it is halted without firing. During this operation, a mechanical blockage of the hammer and firing pin takes place. With the hammer decocked the pistol can still be fired by pulling the trigger. Firing simply requires a longer and heavier pull on the trigger.

FIGURE 5



The locations of the takedown lever, ambidextrous slide stop and ambidextrous “safety”/decocking lever.

FIGURE 6



The ambidextrous “safety”/decocking lever shown in the on safe position.

FIGURE 7



The ambidextrous “safety”/decocking lever shown in the off safe position.

8.1. MANUAL “SAFETY” FUNCTION

- On Safe: To place the pistol in the on safe position, raise the ambidextrous “safety”/decocking lever up with your thumb (Figure 6) until it clicks into place and the red warning dot is completely covered.
- Off Safe: To place the “safety” in the off safe or ready-to-fire position, press the “safety”/decocking lever down, exposing the red warning dot. The red warning dot appears on both sides of the slide (Figure 7).

⚠WARNING

DO NOT DEPEND ON THE RED COLOR ALONE TO INDICATE YOUR FIREARM’S SAFETY STATUS. TIME, EXPOSURE TO THE ELEMENTS, AND THE ABRASIVE ACTION OF CLEANING AGENTS CAN ERASE IT. FAILURE TO FOLLOW THIS WARNING COULD RESULT IN SERIOUS INJURY OR DEATH.

With a cartridge in the chamber and the magazine inserted, the pistol is now ready for firing with a pull on the trigger.

8.2. DECOCKING FUNCTION

▲WARNING

WHEN DECOCKING YOUR PISTOL ALWAYS KEEP THE MUZZLE POINTED IN A SAFE DIRECTION AND KEEP YOUR FINGERS AWAY FROM THE TRIGGER. IMMEDIATELY PLACE THE “SAFETY” IN THE ON SAFE POSITION. FAILURE TO FOLLOW THESE WARNINGS COULD RESULT IN SERIOUS INJURY OR DEATH.

The “safety”/decocking lever also functions as a decocking lever. The “safety”/decocking lever is the appropriate method of lowering the hammer from full cock to the decocked position without having to depress the trigger. With the muzzle pointed in a safe direction and your finger away from the trigger, simply depress the ambidextrous “safety”/decocking lever fully with your thumb (Figure 8). The hammer will lower to the decocked position and the ambidextrous “safety”/decocking lever will return to the off safe position. This requires firm pressure on the “safety”/decocking lever. Do not press the “safety”/decocking lever partially downward, leaving the hammer in the full cock position, and assume the pistol is on safe. If the hammer does not move from the full cock position to the decocked position, the “safety”/decocking lever has not been depressed fully. The “safety” is not in the on safe position until the lever covers the entire red dot on the frame.

▲WARNING

DO NOT ATTEMPT TO MOVE THE HAMMER TO THE DECOCKED POSITION BY PULLING THE TRIGGER AND

FIGURE 8

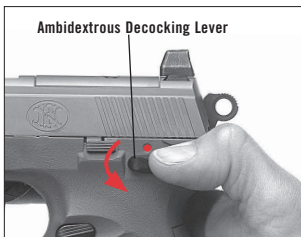

Place the hammer in the decocked position using the ambidextrous decocking lever.

LOWERING THE HAMMER WITH YOUR THUMB. YOUR THUMB MAY SLIP AND CAUSE THE PISTOL TO FIRE, POSSIBLY CAUSING INJURY OR DEATH.

THE HAMMER SHOULD ONLY BE LOWERED TO THE DECOCKED POSITION USING THE AMBIDEXTROUS “SAFETY”/DECOCKING LEVER. WHEN DECOCKING THE HAMMER, ALWAYS MAKE SURE YOUR PISTOL IS POINTED IN A SAFE DIRECTION AND KEEP YOUR FINGERS AWAY FROM THE TRIGGER. ALWAYS BE SURE TO FULLY DEPRESS THE AMBIDEXTROUS “SAFETY”/DECOCKING LEVER TO LOWER THE HAMMER FROM THE FULL COCK TO THE DECOCKED POSITION. BE SURE THE HAMMER MOVES COMPLETELY TO THE DECOCKED POSITION. UNLESS SHOOTING IS IMMINENT, IMMEDIATELY PLACE THE “SAFETY” IN THE ON SAFE POSITION.

9. AMBIDEXTROUS SLIDE STOP

▲WARNING

WHEN USING THE AMBIDEXTROUS SLIDE STOP TO CLOSE THE SLIDE, ALWAYS KEEP THE MUZZLE POINTED IN A SAFE DIRECTION AND KEEP YOUR FINGERS AWAY FROM THE TRIGGER. UNLESS SHOOTING IS IMMINENT, ALWAYS REMOVE THE MAGAZINE FROM THE PISTOL BEFORE CLOSING THE SLIDE TO PREVENT INADVERTENTLY LOADING A CARTRIDGE FROM THE MAGAZINE INTO THE CHAMBER. FAILURE TO FOLLOW THESE WARNINGS COULD RESULT IN SERIOUS INJURY OR DEATH.

MAKE SURE YOUR FINGERS ARE SAFELY AWAY FROM THE EJECTION PORT WHEN THE SLIDE IS RELEASED TO AVOID PINCHING THEM WHEN THE SLIDE CLOSES. FAILURE TO FOLLOW THIS WARNING COULD RESULT IN SERIOUS INJURY.

The ambidextrous slide stop is located on both sides of the frame, above the trigger (Figure 5, page 16). It automatically engages after the last shot in the magazine has been fired. It can also be used to lock the slide in the rearward position when the magazine is removed.

To lock the slide in the open or back position, pull the slide all the way to the rear and press upward on the ambidextrous slide stop.

To release the slide when no magazine is in the pistol and the slide is locked rearward, pull the slide to the rear to disengage the slide stop and allow the slide to return to the forward position or press downward on the ambidextrous slide stop.

FIGURE 9

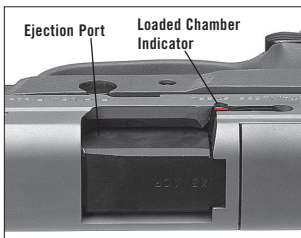

The loaded chamber indicator showing a cartridge is in the chamber.

10. LOADED CHAMBER INDICATOR

The loaded chamber indicator is located at the right side of the slide just behind the ejection port. If it is protruding and showing a red marking, this means that there is a cartridge in the chamber (Figure 9).

11. BEFORE USING THE PISTOL

▲WARNING

CARRY OUT THE FOLLOWING PROCEDURES BEFORE HANDLING, STORING AND/OR TRANSPORTING YOUR PISTOL. FAILURE TO FOLLOW THESE WARNINGS COULD RESULT IN SERIOUS INJURY OR DEATH.

1. Press the ambidextrous magazine release in to eject the magazine. If the magazine does not eject from the magazine well, press and hold the ambidextrous magazine release while gently pulling on the magazine bottom plate.

2. Pull the slide fully rearward and hold it in that position. Press the ambidextrous slide stop upward and lock the slide in the rearward position as detailed in Section 9.
3. Look through the ejection port into the chamber of the pistol in order to ensure that there is no cartridge in the chamber. If there is a cartridge in the chamber, unload the pistol as described in Section 16.1.
4. Release the slide by pushing downward on the ambidextrous slide stop or by pulling rearward on the slide to disengage the slide stop and then let the slide move forward under control.
5. Decock the hammer and place the “safety” in the on safe position as described in Sections 8.1. and 8.2.
6. Ensure that the magazine is empty. If the magazine is not empty, unload it as described in Section 16.2. Unload any spare magazines.

12. CARRYING YOUR PISTOL

▲WARNING

THE RECOMMENDED CARRY POSITION OF YOUR PISTOL IS WITH THE HAMMER IN THE DECOCKED POSITION, THE “SAFETY” IN THE ON SAFE POSITION AND THE CHAMBER EMPTY. FAILURE TO FOLLOW THESE WARNINGS COULD RESULT IN SERIOUS INJURY OR DEATH.

For good safety practice, it is recommended that the pistol is carried with the hammer in the decocked position as explained in Section 8.2. and a cartridge is not chambered until shooting is imminent.

For law enforcement and military personnel, refer to the procedures of your department on carrying a loaded firearm.

13. AMMUNITION

⚠️WARNING

DO NOT USE AMMUNITION OTHER THAN WHAT IS INSCRIBED ON THE LEFT SIDE OF THE SLIDE AND ON THE BARREL. EXAMINE EVERY CARTRIDGE YOU PUT IN YOUR PISTOL. FAILURE TO USE THE CORRECT AMMUNITION MAY RESULT IN SERIOUS INJURY TO YOURSELF OR OTHERS.

The FNP-45 Tactical pistol should only be used with 45 ACP caliber ammunition as indicated by the inscription engraved in the front left side of the slide and the upper rear side of the barrel, visible through the ejection port.

14. LOADING

⚠️WARNING

WHEN LOADING YOUR PISTOL ALWAYS KEEP THE MUZZLE POINTED IN A SAFE DIRECTION, ALWAYS PLACE THE HAMMER IN THE DECOCKED POSITION USING THE DECOCK LEVER, PLACE THE “SAFETY” IN THE ON SAFE POSITION AND KEEP YOUR FINGERS AWAY FROM THE TRIGGER. FAILURE TO FOLLOW THESE WARNINGS COULD RESULT IN SERIOUS INJURY OR DEATH.

14.1. MAGAZINE CAPACITY

FNP-45 magazines are unique for the pistol type and should not be used in other pistols. No other magazine type should be used in your FNP-45 pistol. The specialized, advanced design makes the magazine highly reliable and results in easy maintenance and cleaning.

FNP-45 Tactical pistols have a standard magazine capacity of 15 rounds in the magazine plus one in the chamber, for a total capacity of 16 rounds.

FIGURE 10



FNP-45 10-round magazine.

FIGURE 11



FNP-45 15-round magazine.

Some jurisdictions limit the magazine capacity to 10 rounds plus one in the chamber, for a total capacity of 11 rounds. All FNP-45 Tactical pistols sold in those jurisdictions will be shipped with limited capacity magazines in compliance with local or state law. Make sure you have verified the capacity of your magazine before loading it in your pistol.

IMPORTANT: 10-round magazines for FNP-45 Tactical pistols can be identified by the number “10” stamped under the lowest index hole on the back of the magazine (Figure 10). 10-round magazines have two openings in the rear which allow you to estimate the number of remaining cartridges. If the base of a cartridge is visible in the hole marked 10, the magazine is fully loaded, while the hole marked 5 allows you to estimate the number of cartridges still in the magazine.

15-round magazines for the FNP-45 Tactical can be identified by the number “15” stamped under the lowest index hole on the back of the magazine (Figure 11). 15-round magazines have three openings in the rear which allow you to estimate the number of remaining cartridges. If the base of a cartridge is visible in the hole marked “15,” the magazine is fully loaded, while the holes marked “5” and “10” allow you to estimate the number of cartridges remaining in the magazine.

14.2. LOADING THE MAGAZINE

▲WARNING

IT IS RECOMMENDED ONLY TO LOAD THE NUMBER OF CARTRIDGES YOU INTEND TO SHOOT. DO NOT INSERT THE MAGAZINE BACK INTO THE PISTOL NOR LOAD A CARTRIDGE INTO THE CHAMBER UNLESS SHOOTING IS IMMINENT.

The magazine will drop from the magazine well when the ambidextrous magazine release is pressed (Figure 12). It is recommended to use the thumb of the shooting hand to activate the ambidextrous magazine release. Catch the magazine with the non-shooting hand when it drops out.

As explained in Section 14.1., both 10-round and 15-round magazines are available for FNP-45 Tactical pistols.

1. If the magazine to be loaded is still in the pistol, press on the ambidextrous magazine release in order to eject it.
2. Load the cartridges, one by one, into the magazine. Place the cartridge on the front of the retaining lips and, with your thumb, push it downward against the force of the follower spring and rearwards until it is in position (Figure 13).

FIGURE 12



Press the ambidextrous magazine release and remove the magazine.

FIGURE 13



Load cartridges one at a time into the magazine. (15-round magazine shown).

The openings in the rear of the magazine allow you to estimate the number of cartridges present in the magazine.

14.3. LOADING THE PISTOL

▲WARNING

WHEN LOADING YOUR PISTOL ALWAYS KEEP THE MUZZLE POINTED IN A SAFE DIRECTION AND PLACE THE “SAFETY” IN THE ON SAFE POSITION. ALWAYS CLOSE THE SLIDE AND LOWER THE HAMMER TO THE DECOCKED POSITION BEFORE INSERTING A LOADED MAGAZINE. KEEP YOUR FINGERS AWAY FROM THE TRIGGER. FAILURE TO FOLLOW THESE WARNINGS COULD RESULT IN SERIOUS INJURY OR DEATH.

1. Before loading, ensure that the chamber of the pistol is empty, the pistol does not contain a magazine and that the slide is closed.
2. Insert the loaded magazine into the pistol, being certain that the magazine is pressed completely in and is being retained by the magazine latch (Figure 14).
3. With the muzzle pointed in a safe direction and your fingers away from the trigger, hold the pistol in your firing hand and pull the slide fully rearward with the other hand and release the slide, which returns under recoil spring force (Figure 15, page 26). This movement cocks the hammer and loads the first cartridge from the magazine into the chamber. Allow the slide to “slam” forward under the force of the recoil spring. Do not ease it forward.

FIGURE 14

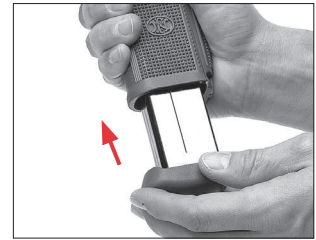

Insert the loaded magazine completely into the grip of the pistol until it latches in place.

FIGURE 15

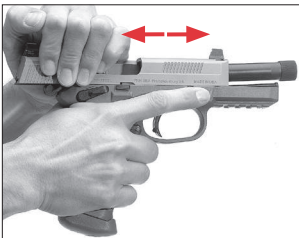

Pull the slide completely rearward and release it, allowing it to move forward freely.

FIGURE 16



Unless shooting is imminent, immediately place the hammer in the decocked position using the ambidextrous decocking lever.

▲WARNING

THE PISTOL IS NOW READY FOR FIRING. UNLESS SHOOTING IS IMMINENT, IMMEDIATELY PLACE THE HAMMER IN THE DECOCKED POSITION USING THE DECOCK LEVER (FIGURE 16) AND PLACE THE “SAFETY” IN THE ON SAFE POSITION AS DESCRIBED IN SECTION 8. FAILURE TO FOLLOW THESE WARNINGS COULD RESULT IN SERIOUS INJURY OR DEATH.

15. FIRING

15.1. FIRING THE PISTOL

▲WARNING

NEVER CHAMBER A CARTRIDGE UNLESS SHOOTING IS IMMINENT. ALWAYS KEEP THE MUZZLE POINTED IN A SAFE DIRECTION AND PLACE THE “SAFETY” IN THE ON SAFE POSITION. NEVER TRY TO COCK THE HAMMER BY PULLING THE TRIGGER.

FAILURE TO FOLLOW THESE WARNINGS COULD RESULT IN SERIOUS INJURY OR DEATH.

DO NOT USE UNORTHODOX SIGHTING METHODS. WHEN FIRING THE SLIDE MOVES REARWARD ABOUT ONE INCH PAST THE REAR OF THE FRAME. TO PREVENT THE SLIDE FROM CAUSING INJURY IN ITS REARWARD MOVEMENT WHEN SHOOTING KEEP THE PISTOL AWAY FROM THE EYES OR FACE, AND NEITHER HAND SHOULD BE IN A POSITION WHERE IT COULD BE HIT BY THE SLIDE. FAILURE TO FOLLOW THIS WARNING COULD RESULT IN SERIOUS INJURY.

1. Ensure that the procedures in Section 17 “Cleaning and Lubrication” have been carried out.
2. Load a cartridge into the chamber as detailed in Section 14.3. Immediately place the hammer in the decocked position.
3. With a cartridge in the chamber and the “safety” in the off safe position, you need only take aim at your target and squeeze the trigger to fire the pistol.

If the hammer is in the decocked position, the first shot will be double-action with a heavier and longer trigger pull. If the hammer is not manually decocked after the first double-action shot, the following shot will be single-action with a lighter and shorter trigger pull.
4. After a cartridge has been fired, the slide moves rearward, ejects the empty case, cocks the hammer, then returns forward loading a cartridge from the magazine into the chamber. You may continue to fire the pistol until the magazine is empty by pulling the trigger to fire each cartridge.

When firing is no longer imminent, immediately decock the hammer as described in Section 8.2. to place the pistol in the double-action condition and place the “safety” in the on safe position as described in Section 8.1.

After the last cartridge in the magazine is fired, the slide stop will engage the slide and automatically hold the slide in the open or rearward position (Figure 17).

If firing is no longer imminent and you are finished shooting, remove the magazine and close the slide by pushing down on the ambidextrous slide stop or pulling the slide rearward to disengage the slide stop and allow the slide to return to the forward position. Decock the hammer as described in Section 8.2. to place the pistol in the double-action condition and then place the “safety” in the on safe position as described in Section 8.1.

For law enforcement and military personnel, refer to the procedures of your department on carrying a loaded firearm.

FIGURE 17



The slide locks to the rear after the last cartridge has been fired.

15.2. RELOADING DURING FIRING

▲WARNING

NEVER CHAMBER A CARTRIDGE UNLESS SHOOTING IS IMMINENT. ALWAYS KEEP THE MUZZLE POINTED IN A SAFE DIRECTION. MAKE SURE YOUR FINGERS ARE SAFELY AWAY FROM THE CHAMBER WHEN THE SLIDE IS RELEASED TO AVOID PINCHING THEM WHEN THE SLIDE CLOSES. FAILURE TO FOLLOW THESE WARNINGS COULD RESULT IN SERIOUS INJURY OR DEATH.

After firing the last cartridge, the slide will remain in the open position. If firing is imminent, the empty magazine can quickly be replaced with a loaded magazine as follows:

1. Press on the ambidextrous magazine release to eject the empty magazine.
2. Insert a loaded magazine completely into the magazine well until it locks into position.
3. Release the slide by pulling rearward on the slide to disengage the slide stop. This will allow the slide to move forward and chamber a cartridge. You can also press down on the slide stop to allow the slide to move forward and chamber a cartridge. Note that when the slide closes that the hammer is in the cocked position and the pistol is ready to fire in single-action mode. You may now continue firing.
4. If firing is no longer imminent and you are finished shooting, remove the magazine and close the slide by pushing down on the ambidextrous slide stop or pulling the slide rearward to disengage the slide stop and allow the slide to return to the forward position. Decock the hammer as described in Section 8.2. to place the pistol in the double-action condition and then place the “safety” in the on safe position as described in Section 8.1.

For law enforcement and military personnel, refer to the procedures of your department on carrying a loaded firearm.

16. UNLOADING

▲WARNING

WHILE UNLOADING YOUR PISTOL ALWAYS KEEP THE MUZZLE POINTED IN A SAFE DIRECTION, PLACE THE “SAFETY” IN THE ON SAFE POSITION AND KEEP YOUR FINGERS AWAY FROM THE TRIGGER. WHEN UNLOADING IT IS VITAL THAT YOU REMOVE THE MAGAZINE FROM YOUR PISTOL SO THAT A CARTRIDGE IS NOT CHAMBERED WHEN YOU CLOSE THE SLIDE. FAILURE TO FOLLOW THESE WARNINGS COULD RESULT IN SERIOUS INJURY OR DEATH.

16.1. UNLOADING THE PISTOL

1. If the hammer is cocked, decock it and place the “safety” in the on safe position as described in Sections 8.1. and 8.2.
2. Press the ambidextrous magazine release and remove the magazine. If the magazine does not drop out of the pistol, pull gently on the bottom plate while pressing the ambidextrous magazine release.
3. If the slide is closed, remove the magazine and then pull back on the slide and eject any cartridge in the chamber. Lock the slide to the rear by pressing the ambidextrous slide stop up as described in Section 9.
4. Inspect the chamber to ensure there is no cartridge present.
5. When you are certain your pistol is completely unloaded, release the slide by pulling rearward on the slide to disengage the slide stop or press down on the slide stop to allow the slide to move forward slowly under your control.
6. Decock the hammer and place the “safety” in the on safe position as described in Sections 8.1. and 8.2.
7. Unload the magazines as explained in Section 16.2.

16.2. UNLOADING THE MAGAZINE

1. Depress the ambidextrous magazine release and remove the magazine.
2. Unload the pistol and place it in a safe condition as detailed in Section 16.1.
3. Strip the cartridges from the magazine by pushing forward on the rim of the top cartridge and sliding each cartridge out, one at a time, as each moves up in the magazine until the magazine is empty. Repeat this procedure with all loaded magazines.

17. CLEANING AND LUBRICATION



BEFORE PERFORMING CLEANING PROCEDURES, MAKE SURE THE PISTOL IS COMPLETELY UNLOADED (SECTION 16). ALWAYS KEEP THE MUZZLE POINTED IN A SAFE DIRECTION AND PLACE THE “SAFETY” IN THE ON SAFE POSITION. FAILURE TO FOLLOW THESE WARNINGS COULD RESULT IN SERIOUS INJURY OR DEATH.

WEAR EYE PROTECTION WHEN DISASSEMBLING, ASSEMBLING AND CLEANING YOUR PISTOL AND MAGAZINE TO PREVENT SPRINGS, SPRING-LOADED PARTS, SOLVENTS OR OTHER AGENTS FROM CONTACTING YOUR EYES, RESULTING IN INJURY.

KEEP ALL AMMUNITION AWAY FROM THE CLEANING AREA. NEVER TEST THE MECHANICAL FUNCTION OF YOUR PISTOL WITH LIVE AMMUNITION. FAILURE TO FOLLOW THESE WARNINGS COULD RESULT IN SERIOUS INJURY OR DEATH.

NOTICE! NEVER SOAK YOUR FIREARM IN HYDROCARBONS, AMMONIA, TRICHLOROETHYLENE OR TEFLON®-BASED LUBRICANTS AS THEY CAN DAMAGE TO YOUR PISTOL.

Your pistol will function better and more reliably over a longer period of time if it is properly maintained and kept clean.

The frequency at which the pistol should be cleaned and lubricated depends on external factors such as the weather and shooting conditions as dirt and moisture can affect the functioning of even the finest firearm. Excessively dirty ammunition may require more frequent cleaning.

Clean and lubricate your pistol after every use or, in case of intensive shooting, every 500 rounds. A minimum cleaning includes wiping down the pistol and lubricating key parts. Most regular maintenance also includes disassembly and cleaning the barrel. If you encounter a function problem, thoroughly clean the pistol to see if it solves the problem before seeking the services of a qualified gunsmith or FNH USA Customer Support.

It is important to keep your pistol clean and correctly lubricated, however, the polymer frame of the FNP-45 Tactical pistol does not require lubrication.

NOTICE! DO NOT USE EXCESSIVE LUBRICANT. USING TOO MUCH LUBRICANT CAN INTERFERE WITH THE FUNCTIONING OF YOUR PISTOL.

17.1. DISASSEMBLING THE PISTOL

It is very important to become familiar with the disassembly procedure of the pistol as disassembly is required during the cleaning and lubrication procedure which ensures reliable operation of the pistol.

1. Completely unload the pistol as described in Section 16.1.
2. Pull the slide fully rearward and lock it into its rear position by pressing the ambidextrous slide stop upward.
3. Unscrew the thread protector on the end of the barrel (Figure 18).
4. Rotate the takedown lever 90° clockwise (Figure 19).

FIGURE 19



Rotate the takedown lever downward.

FIGURE 18



Unscrew the thread protector from the muzzle.

FIGURE 20

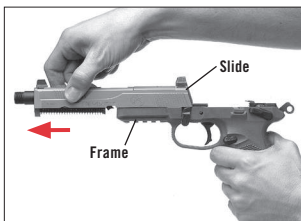

Move the slide forward and off of the frame.

FIGURE 21

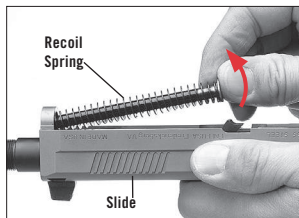

Remove the recoil spring from the slide.

FIGURE 22

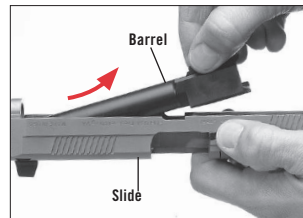

Remove the barrel from the slide.

5. While holding the slide with one hand, release the slide by pushing downward on the ambidextrous slide stop. Be sure to have a firm grip on the slide as it is under pressure of the recoil spring.
6. Still holding the slide, let it slowly return forward and continue this movement in order to separate the slide from the frame (Figure 20).
7. Hold the slide upside down.
8. While gently compressing the recoil spring, release the rear from the spring up and out of the slide (Figure 21).
9. Grip the barrel by its lug and then lift it up and out of the slide (Figure 22).

FIGURE 23



Do not disassemble the pistol beyond this point.

This level of disassembly (Figure 23) is sufficient to perform a thorough cleaning. Further disassembly should only be carried out by an authorized armorer or by the FNH USA Product Service Center.

17.2. CLEANING AND LUBRICATION

1. Completely unload the pistol as described in Section 16.1.
2. Disassemble the pistol as described in Section 17.1.
3. Using a cleaning brush or spray, apply solvent inside the barrel and allow it to penetrate.
4. Using the correct size cleaning rod, jag and patches, work them back and forth to remove the solvent from the inside of the barrel until patches come out clean.

NOTICE! BE CAREFUL NOT TO SCRATCH OR DAMAGE THE MUZZLE AS THIS CAN AFFECT ACCURACY. IT IS RECOMMENDED TO ONLY CLEAN THE BARREL FROM THE CHAMBER END.

5. When the barrel is clean, again use a cleaning rod and patch, this time moistened with storage lubricant, to protect the inside of the barrel until the next use. Remember to wipe the inside of the barrel dry before shooting as detailed in Section 17.1.
6. Use a brush and solvent to remove carbon and deposits from the slide, chamber, extractor and areas that attract powder and primer residue.
7. Use a soft cloth or a rag, and solvent if necessary, to remove dirt from the magazine housing of the frame.

⚠ WARNING

MOST SOLVENTS ARE HIGHLY FLAMMABLE. WEAR EYE PROTECTION AND PRACTICE APPROPRIATE SAFETY MEASURES WHEN WORKING WITH SOLVENTS TO AVOID SERIOUS INJURY.

8. Thoroughly clean all of the parts of the pistol.

FIGURE 24

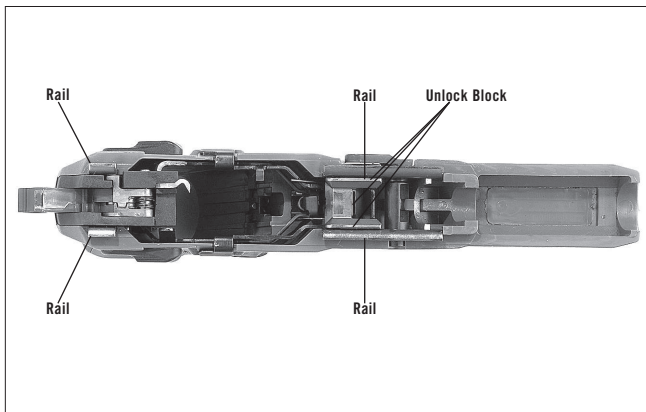

Lubricate the frame at these locations.

FIGURE 25

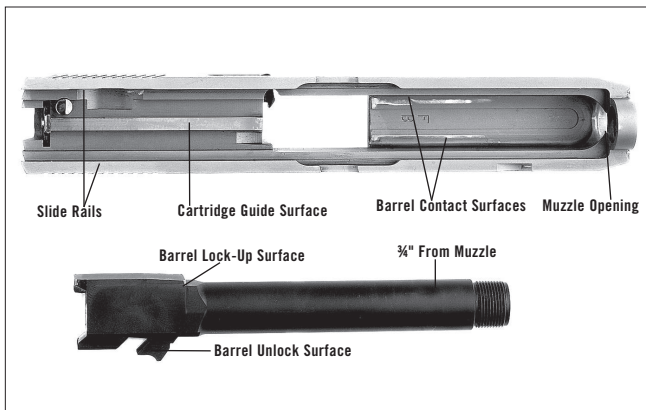

Lubricate the slide and barrel at these locations.

9. Check the disassembled parts of the pistol for signs of wear and/or damage. In case of doubt about the condition of a part, consult your dealer or departmental armorer.
10. Using a soft cloth moistened with storage lubricant, lightly apply lightweight gun oil to all the external surfaces of the metal parts. The polymer grip does not require lubrication.
11. Apply one drop of lubricant to the locations shown in Figure 24 and Figure 25 (page 35).
12. Assemble the slide, the barrel and the recoil spring.
13. Assemble the pistol as described in Section 17.3.
14. Clean the outside of the pistol in order to remove dirt, fingerprints and excess lubricant.

17.3. ASSEMBLING THE PISTOL

To assemble the pistol, follow the steps listed in Section 17.1. in reverse order, taking into account the following points:

1. Insert the barrel into the slide and ensure the muzzle is oriented correctly.
2. Ensure that the front end of the recoil spring fits correctly into its position in the slide and that the rear end of the spring fits correctly onto the barrel lug.
3. Line up the grooves in the slide correctly with the guides on the frame and replace the slide on the frame.

IMPORTANT: Please note that the slide cannot be fitted onto the frame when a magazine has been inserted into the pistol grip.

IMPORTANT: If, for any reason, the hammer is decocked, cock it by pulling it back with the thumb in order to facilitate the installation of the slide.

4. Pull the slide completely to the rear and lift up on the ambidextrous slide stop to lock the slide back.
5. Rotate the takedown lever 90° counterclockwise.
6. Pull the slide rearward to release the ambidextrous slide lock and ease the slide forward.
7. After reassembling the pistol, decock the hammer and place the “safety” in the on safe position as described in Sections 8.1. and 8.2.

17.4. DISASSEMBLING THE MAGAZINE



WEAR EYE PROTECTION WHEN DISASSEMBLING, ASSEMBLING AND CLEANING YOUR PISTOL AND MAGAZINE TO PREVENT SPRINGS, SPRING-LOADED PARTS, SOLVENTS OR OTHER AGENTS FROM CONTACTING YOUR EYES, RESULTING IN INJURY.

Disassembling the magazine takes only a few seconds and should be a part of the pistol's normal maintenance.

1. If not already done, press the ambidextrous magazine release in order to eject the magazine from the pistol and unload it completely (refer to Section 16.2.).
2. Using a tool such as a small screwdriver, press on the protruding part of the magazine retainer through the hole in the magazine bottom plate (Figure 26). Hold the retainer in that position and then slide the magazine bottom plate slightly forward (Figure 27, page 38).

FIGURE 26



Use a small instrument to press the floorplate retainer.

- While holding the magazine bottom catch (which is subjected to the force of the magazine spring) in position, slide the magazine bottom plate off the magazine body and then carefully release the magazine spring which is under pressure.
- Remove the magazine spring together with the follower and retainer.

FIGURE 27



Slide the floorplate forward partially to secure the magazine spring.

This level of disassembly is sufficient to perform thorough cleaning (Figure 28). Further disassembly should only be carried out by an authorized armorer or by the FNH USA Product Service Center.

17.5. CLEANING AND LUBRICATION OF THE MAGAZINE

- Disassemble the magazine as shown in Section 17.4.
- Use a soft cloth or a rag to clean all the parts of the magazine.
- Using a soft cloth moistened with lubricant, lightly apply lubricant to all the external surfaces of the metal parts. Wipe off excess lubricant. Ensure that the inside of the magazine is dry.
- Reassemble the magazine as detailed in Section 17.6.

17.6. ASSEMBLING THE MAGAZINE

- With the components of the magazine clean, ensure that the magazine follower and the magazine bottom catch fit correctly onto the follower spring and that the assembly is oriented correctly.

FIGURE 28

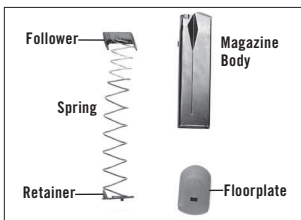

The magazine shown disassembled.

- Insert the magazine spring, together with the follower and retainer, into the magazine body.
- While holding the magazine spring in the magazine body, slide the magazine bottom plate onto the magazine body. The magazine bottom plate can only be slid back into position when the magazine bottom catch is pushed far enough into the magazine body.
- Ensure that the magazine bottom plate correctly locks into position.

18. TAKING CARE OF THE PISTOL

NOTICE! NEVER ATTEMPT TO TAKE YOUR PISTOL APART FURTHER THAN EXPLAINED IN THIS OWNER'S MANUAL. YOUR PISTOL IS A SPECIALIZED, FINELY FITTED MECHANISM. YOU MAY PERMANENTLY DAMAGE IT BY ATTEMPTING TO DISASSEMBLE THE INNER MECHANISM ASSEMBLIES. IF FURTHER DISASSEMBLY FOR SERVICE OR CLEANING IS REQUIRED, TAKE YOUR FIREARM TO A QUALIFIED GUNSMITH, OR SEND IT TO OUR ARNOLD, MISSOURI SERVICE FACILITY AS EXPLAINED IN SECTION 24 UNDER "WARRANTY, SERVICE AND TECHNICAL QUESTIONS."

NOTICE! YOUR PISTOL SHOULD BE INSPECTED EVERY 2000 ROUNDS AND/OR ONCE A YEAR BY A QUALIFIED GUNSMITH OR THE FNH USA PRODUCT SERVICE CENTER BECAUSE DAMAGE, WEAR AND CORROSION ARE NOT ALWAYS VISIBLE FROM THE OUTSIDE. LAW ENFORCEMENT AND MILITARY PERSONNEL SHOULD CONTACT THEIR DEPARTMENTAL ARMORER WHO WILL INSPECT THE PISTOL ON A YEARLY BASIS.

NOTICE! IF THE OPERATION OF THE PISTOL SEEMS ABNORMAL, REPORT IT TO YOUR DEALER OR DEPARTMENTAL ARMORER IMMEDIATELY.

- Always keep the pistol in immaculate condition and good working order.
- Always clean and lubricate the pistol after use.
- Regularly inspect the pistol, its parts and accessories.

19. ACCESSORIES

19.1. INTERCHANGEABLE BACKSTRAPS

⚠️ WARNING

BEFORE CHANGING BACKSTRAPS, MAKE SURE THE PISTOL IS COMPLETELY UNLOADED (SECTION 16). ALWAYS KEEP THE MUZZLE POINTED IN A SAFE DIRECTION AND PLACE THE “SAFETY” IN THE ON SAFE POSITION. FAILURE TO FOLLOW THESE WARNINGS COULD RESULT IN SERIOUS INJURY OR DEATH.

In order to optimize grip on the pistol as a function of the ergonomics of the shooter, four backstraps are supplied (Figure 29). One backstrap is installed on the pistol at the factory. The backstrap can be replaced as follows:

1. Insert a $\frac{1}{16}$ " punch or other small instrument into the hole in the backstrap and gently push inward to release the internal locking tab (Figure 30).

FIGURE 29

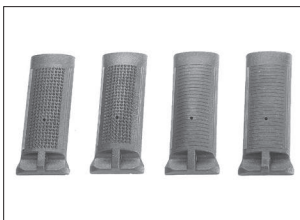

Four accessory backstraps are included.

FIGURE 30

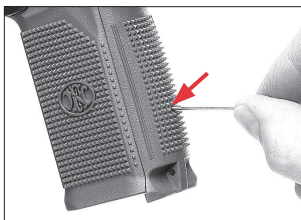

Use a small instrument to press the backstrap retainer.

2. Maintain light pressure on the punch and slide the backstrap downward, off the grip (Figure 31).
3. Install the desired backstrap by sliding it up the rail. It will snap into place.

FIGURE 31

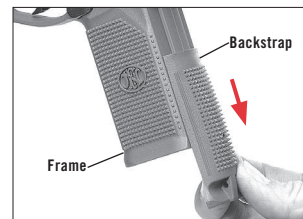

Slide the backstrap down and off of the frame.

19.2. ACCESSORY RAIL

The frame of the FNP-45 Tactical features a rail on which accessories, such as a laser sight or flashlight, can be installed. Follow the instructions included with the accessory when mounting accessories to your pistol.

20. COMBAT SIGHTS

The high profile combat sights are factory set for a combat hold (point of aim equals point of impact) at 20 yards. This may vary slightly with different types of ammunition.

Do not try to adjust the sights yourself. Send the pistol to the FNH USA Product Service Center, your departmental armorer or a qualified gunsmith for this adjustment.

21. MOUNTING ELECTRONIC SIGHTS

⚠️ WARNING

BEFORE MOUNTING A SIGHT, MAKE SURE THE PISTOL IS COMPLETELY UNLOADED (SECTION 16). ALWAYS KEEP THE MUZZLE POINTED IN A SAFE DIRECTION AND PLACE THE “SAFETY” IN THE ON SAFE POSITION. FAILURE TO FOLLOW THESE WARNINGS COULD RESULT IN SERIOUS INJURY OR DEATH.

FIGURE 32

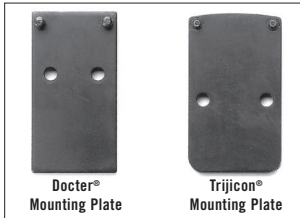

Two mounting plates are included.

FIGURE 33

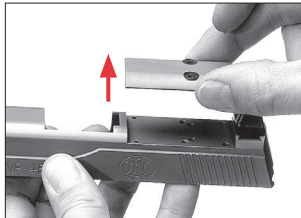

Remove the slide cap.

The stainless steel slide of the FNP-45 Tactical is cut to accept an optional electronic red dot sight (electronic sights not included). Two mounting bases are included to fit Trijicon® or Docter® red-dot electronic sights (Figure 32). To install an electronic sight on the FNP-45 Tactical follow the instructions beginning on page 42.

21.1. DOCTER® AND TRIJICON® ELECTRONIC SIGHTS

1. Completely unload the pistol as described in Section 16.
2. Disassemble the pistol as described in Section 17.1.
3. Use a T10 TORX® wrench to remove the two screws that hold the slide cap in place and remove the slide cap (Figure 33).
4. Install the correct mounting plate, lining up the pins on the mounting plate with the holes in the slide as shown in Figure 34 (Docter®) or Figure 35 (Trijicon®).
5. Place the sight onto the mounting plate, lining up the holes in the sight with the mounting plate pins.
6. Apply a drop of medium-strength threadlocker to the mounting screws and tighten them with T10 Torx® wrench (Docter®) or T15 Torx® wrench (Trijicon®).

NOTICE! DO NOT OVERTIGHTEN THE SCREWS.

FIGURE 34

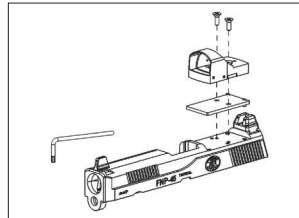

Docter® installation.

FIGURE 35

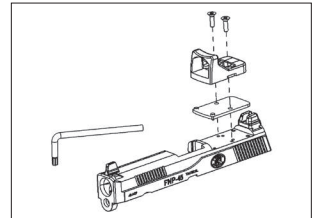

Trijicon® installation.

7. Assemble the pistol as described in Section 17.3.
8. Zero the sight according to the sight manufacturers' instructions.

21.2. C-MORE SYSTEMS™ STS AND FNH USA SIGHTS

1. Completely unload the pistol as described in Section 16.
2. Disassemble the pistol as described in Section 17.1.
3. Use a T10 TORX® wrench to remove the two screws that hold the slide cap in place and remove the slide cap (Figure 33).
4. Install the sight onto the slide, lining up the holes in the sight with the holes in the slide (Figure 37). These sights do not require a mounting plate.

FIGURE 36



Trijicon® sight installed with mounting plate.

FIGURE 37



FNH USA sight installed without mounting plate.

5. Apply a drop of medium-strength threadlocker to the mounting screws and tighten them with the T10 Torx® wrench.

NOTICE! DO NOT OVERTIGHTEN THE SCREWS.

6. Assemble the pistol as described in Section 17.3.
7. Zero the sight according to the sight manufacturers' instructions.

22. THREADED MUZZLE

⚠️WARNING

BEFORE ATTACHING ANY BARREL ACCESSORIES, MAKE SURE THE PISTOL IS COMPLETELY UNLOADED (SECTION 16). ALWAYS KEEP THE MUZZLE POINTED IN A SAFE DIRECTION AND PLACE THE "SAFETY" IN THE ON SAFE POSITION. FAILURE TO FOLLOW THESE WARNINGS COULD RESULT IN SERIOUS INJURY OR DEATH.

The FNP-45 Tactical features an extended, threaded muzzle to accept sound suppressors, compensators and other accessories. When installing aftermarket accessories on the pistol, follow the manufacturers' guidelines.

IMPORTANT: Before using any accessories check your local, state and federal laws to insure owning and using sound suppressors, compensators and other accessories are in compliance with local, state and federal laws.

23. TROUBLESHOOTING

If a problem cannot be solved by the few directives given below, the pistol should not be used and should be examined by your dealer or departmental armorer.

- **The cartridge is not chambered.**
The magazine has not been inserted correctly, is dirty or damaged.
Improper ammunition is used.
The magazine has not been loaded correctly.

- **The slide does not close properly.**
See previous page.
Pistol is dirty or excessively lubricated.
- **The empty case jams in the chamber or at the ejection port.**
Insufficient recoil due to the pistol being dirty.
The ammunition gives insufficient recoil force.
Pistol is inadequately lubricated.
Pistol is dirty or too heavily lubricated.
- **Hammer strikes but no discharge.**
Defective cartridge.
Hard primers.

24. WARRANTY, SERVICE AND TECHNICAL QUESTIONS

For technical questions about service or your firearm contact:

FNH USA Customer Support
Phone: (703) 288-1292 ext. 122 or 104

If your FNH USA product should require service or repair contact the FNH USA Product Service Center in Arnold, Missouri. Law enforcement and military users should contact their department or unit armorer.

FNH USA Product Service Center
3005 Arnold Tenbrook Road
Arnold, MO 63010-4728
Phone: (800) 635-1321

When returning your FNH USA firearm for servicing you must do the following:

1. Be sure it is completely unloaded.
2. Remove the scope, optics or accessories.
3. Package it securely in a cardboard container.

4. Enclose the service/repair form available at www.fnhusa.com or a letter that clearly describes the trouble experienced, the ammunition used and the repairs desired. Also include your name and a daytime phone number where you can be reached.
5. If convenient, send a copy of the service/repair form or letter to us separately.
6. Never return ammunition with your firearm. It is against postal and most commerce regulations.

25. SERVICE POLICY

If you have any questions about this owner's manual or other FNH USA products, contact:

FNH USA, LLC

Commercial and Law Enforcement Sales

Phone: (703) 288-1292, extension 122 or 104

Or visit us online at www.fnhusa.com

IF YOU DO NOT UNDERSTAND THE INSTRUCTIONS FOR OPERATING YOUR FNH USA FIREARM, IT IS YOUR RESPONSIBILITY TO CONTACT FNH USA CUSTOMER SUPPORT AT (703) 288-1292 EXT. 122 OR 104 BEFORE USING THE FIREARM.

This owner's manual should always accompany this pistol and be transferred with it upon any change of ownership.

FNH USA products are serviced by the FNH USA Product Service Center in Arnold, Missouri.

Please call (703) 288-1292 ext. 122 or 104 to discuss any product repair requirements.

Shipping Address:

FNH USA Product Service Center

3005 Arnold Tenbrook Road

Arnold, MO 63010-4728

26. TECHNICAL SPECIFICATIONS

Caliber	: 45 ACP
Type of fire	: Double-Action/Single Action Autoloader
Trigger pull	: Single-action : 3.75-6.0 lbs. Double-action : 8.0-10.0 lbs.
Weight	: Without magazine : 29.9 oz. With empty 15-round magazine : 33.2 oz. With full 15-round magazine : 43.2 oz.
Length	: 7.87"
Height	: 6.33"
Width	: 1.58"
Barrel length	: 5.3" (bore and chamber)
Rifled length	: 3.65"
Number of grooves	: 6
Twist and direction	: 1:16", right-hand
Magazine capacity	: 10-rounds (limited-capacity magazine) 15-rounds (high-capacity magazine)
Sight Radius	: 6"
Effective range	: 55 yd.
Lethal range	: 886 yd.
Maximum range	: 1887 yd.

All specifications subject to changes without notice.



FNH USA
www.fnhusa.com