

UZI 9 mm semi-automatic carbine model B

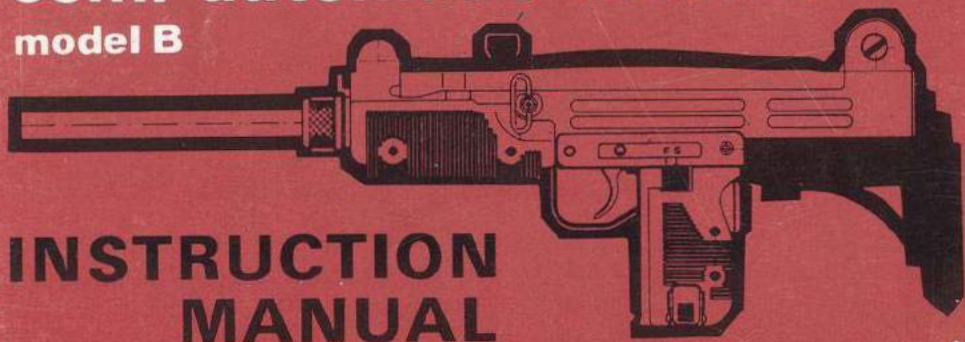

INSTRUCTION MANUAL



ISRAEL MILITARY INDUSTRIES

Welcome to the proud family of Uzi Carbine owners.

In acquiring your new Uzi Carbine, a semi-automatic version of the world renowned Uzi, you have chosen a firearm famous for its accuracy and reliability; a firearm which will give you many years of complete satisfaction in its use.

To get the most out of your Uzi Carbine, please read this manual from cover to cover before handling and operating the Carbine for the first time.

WARNING!

IT IS DANGEROUS TO ALTER OR MODIFY THIS FIREARM IN **ANY** WAY. ANY ALTERATION OR MODIFICATION OF THE FIRING MECHANISM MAY RESULT IN THIS FIREARM BECOMING UNSAFE. ANY ATTEMPT TO ALTER OR MODIFY THIS FIREARM IS ILLEGAL AND WILL NULLIFY ALL WARRANTIES AND WILL BE SUBJECT TO IMMEDIATE NOTIFICATION OF APPROPRIATE FEDERAL LAW ENFORCEMENT AGENCIES.

TABLE OF CONTENTS

	Page
SAFETY PRECAUTIONS	4
SPECIFICATIONS	6
FACTS ABOUT YOUR UZI	8
DISASSEMBLY AND ASSEMBLY	14
Barrel	14
Cover and Bolt Assemblies	15
Magazine	19
OPERATING INSTRUCTIONS	21
Stock	21
Magazine	24
Loading and Unloading	25
Precautions before Firing	28
Aiming and Firing	28
Zeroing	30

	Page
CARE AND CLEANING	31
Initial	31
Periodic	32
Before and after Firing	33
Additional Disassembly	35
IMMEDIATE ACTION AND TROUBLE SHOOTING	41

SAFETY PRECAUTIONS

Make sure that the carbine is unloaded before:

- Receiving or handing over a carbine.
- Transporting the carbine.
- Cleaning or disassembly.

Always remove the magazine immediately after firing and make sure that the chamber is empty.

Make sure that the fire selector (safety catch) is on "S" (Safe) position to guarantee that the carbine is safe whenever:

- Inserting magazine.
- You have stopped firing it.
- The carbine is being transported or moved.
- The carbine is not in use.

When handling the carbine:

- Never point it at a person.
- Always make sure that the barrel points in a safe direction.
- Always assume that the carbine is loaded.

Never load a carbine until you are ready to use it. Practice handling the carbine empty before attempting to fire (The UZI may be dry fired without harm to the carbine).

Whenever the short (display) barrel is installed:

- Never insert a loaded magazine.
- Never attempt to fire the carbine.

Before shooting the carbine:

- Always wear eye and ear protection.

4

- Always be sure of target backstop and what lies beyond it.

Use only clean, dry, original high quality currently commercially manufactured 9 mm ammunition in good condition. Reloaded or remanufactured ammunition should not be used. Use of this type of ammunition will void all warranties.

Never handle ammunition with oily fingers.

The UZI Semi-Automatic Carbine can be fired under some circumstances with the bolt open or partly open, by pulling the trigger. Therefore, user should be careful to keep fingers clear of the trigger whenever:

- Extracting a live round from the chamber.
- Checking an obstruction lodged in the chamber.
- Looking into the ejection port area.
- Opening or closing the bolt whenever there is a round in the chamber or magazine.

Make sure that the barrel is fully seated before firing, as described on page 15.

REMEMBER: ALWAYS ASSUME THAT THE CARBINE IS LOADED: LOOKING INTO THE END OF THE BARREL (MUZZLE) IS NOT RECOMMENDED AT ANY TIME.

5

SPECIFICATIONS

WEIGHT

Carbine, empty	3.8 kg (8.4 lb)
Carbine, fully loaded	4.3 kg (9.5 lb)
Magazine, empty	200 g (0.45 lb)
Magazine, 25 rounds, full	500 g (1.1 lb)

LENGTH

Overall, metal stock extended	800 mm (31.5 in)
Overall, metal stock folded	610 mm (24.0 in)

MECHANICAL FEATURES

Method of operation and breech closure	Blowback firing from closed bolt with floating firing pin
Method of feeding	Magazine
Ejection	Through port at right side

BARREL

Length	410 mm (16.1 in)
Rifling	R.H. 4 grooves, 1 turn in 254 mm (10 in)

6

AMMUNITION

Caliber	9 mm Parabellum
Type	Ball & Hollow Point

FIRING CHARACTERISTICS

Muzzle Velocity*	380-460 m/sec (1250-1500 ft/sec)
Maximum Range	up to 2000 m (2200 yds) at 30° upward

SIGHTS

Sight Radius	309 mm (12.2 in)
Front Sight	Post type (adjustable for elevation)
Rear Sight	Aperture "L" flip type for 100 m and 200 m (330 ft and 660 ft) (adjustable for windage)

SAFETIES

Fire Selector (safety catch)	Safe and semi-automatic
Safety Grip	Blocks sear and breech

* Depending upon type of ammunition used.

FACTS ABOUT YOUR UZI SEMI-AUTOMATIC CARBINE

The UZI Semi-Automatic Carbine is a lightweight, magazine-fed firearm with a stock for shoulder firing. It is blowback operated and fires from a closed breech with a floating firing pin.

A brief description of the UZI Semi-Automatic follows:

Refer to illustration, (see page 10).

- The barrel (8) is attached to the receiver (11) by the barrel retaining nut (9).



UZI with metal stock — left hand view.

8

- The barrel retaining nut catch (1) is on the front end of the receiver (11).
- The front (2) and rear sights (6) and their guards are located on the front and rear top ends of the receiver.
- The plastic hand guard (10) is attached to the front end of the receiver. The front carrying sling swivel is located on the receiver at the left top side of the hand guard.
- The receiver cover (4), with cocking knob (3), is located on top of the receiver.
- The bolt and striker assembly travel inside the receiver (11).
- The bolt and striker assembly each accommodates its return spring.
- The pistol grip (13) is attached to the center lower part of the receiver (11).
- The fire selector (14) is located at the top of the left side of the pistol grip (13).
- The magazine catch (16) is located on the lower left side of the pistol grip (13).
- The trigger (12) and its guard are located in front of the pistol grip (13).
- The grip safety (15) is located at the rear upper part of the pistol grip (13).
- The stock (7) is attached to the rear end of the receiver (11). The rear carrying sling loop is attached to the left side of the stock (7).

9

SAFETIES

The UZI Semi-Automatic carbine has two safeties:

- Fire Selector (Safety Catch)
- Grip Safety

These safeties are independent of each other and minimize the possibility of accidental firing when in the safe position.

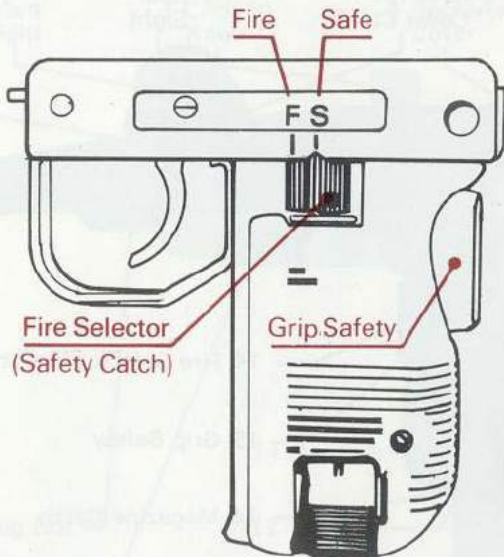

12

STRIPPING

Servicing of the UZI is simple: only SEVEN parts need to be handled when stripping. No tools are required when stripping the UZI.

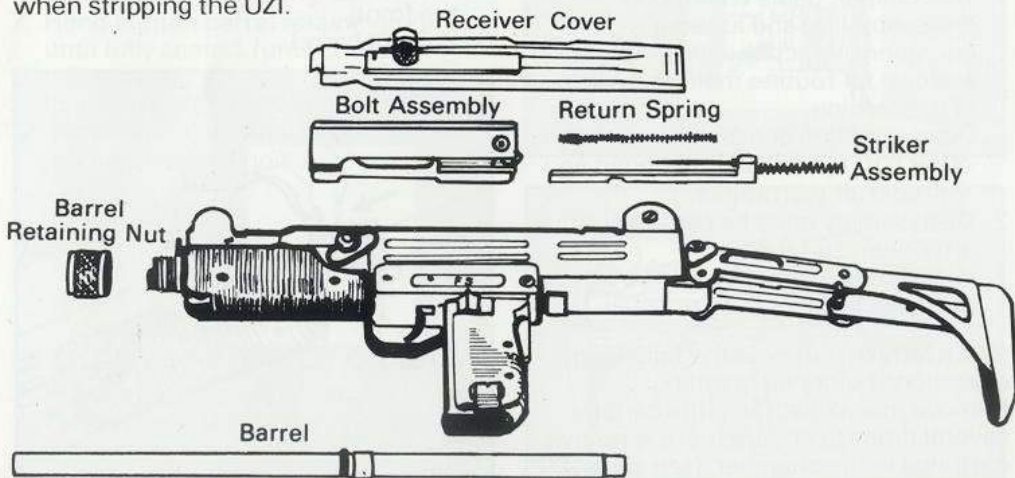

13

DISASSEMBLY AND ASSEMBLY

GENERAL

1. This chapter deals with those disassembling and assembling operations which the user may perform for routine maintenance of the carbine.
Disassembling or assembling of any other part is not recommended and will void all warranties.
2. Disassembly must be carried out on a clean surface and disassembled parts should be placed in order of their removal.

WARNING: Carry out the following operations before dismantling: Remove magazine. Clear the carbine several times to ensure there is no live cartridge in the chamber. (see page 27).

REMOVING THE BARREL

1. Depress barrel retaining nut catch. (fig. 1).
2. Unscrew barrel retaining nut counter-clockwise (looking from the front).
3. Pull out barrel.

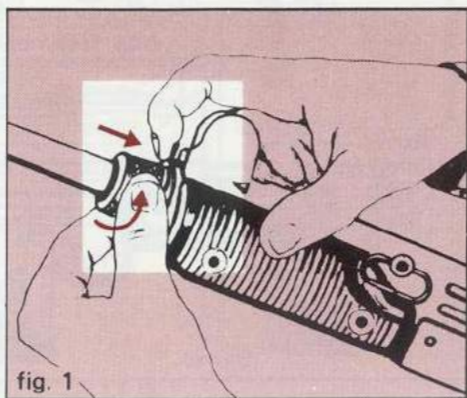

14

INSTALLING THE BARREL

1. Insert barrel into place. Make sure that the FLATS on the barrel line up with the FLATS on the barrel housing protrusion. (fig. 2).
2. Hand tighten barrel retaining nut until fully seated. (until clicking noise stops).
3. If barrel is not fully seated, turning barrel retaining nut will not produce clicking noise.

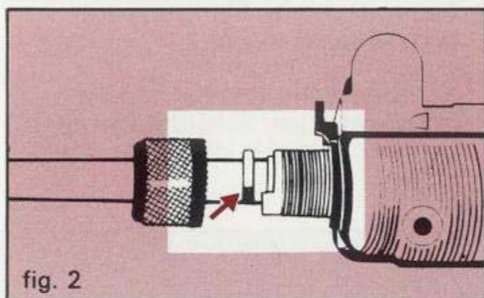

REMOVING RECEIVER COVER

1. Hold down receiver cover.
2. Push cover catch to the rear. (fig. 3).

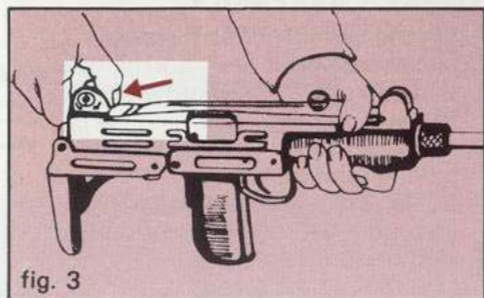

cont. ▶

3. Remove cover by lifting upward and rearward. (fig. 4).

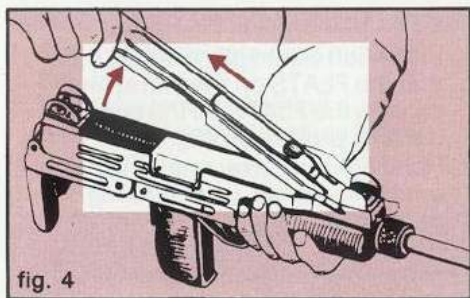

REMOVING THE BOLT AND STRIKER ASSEMBLY

1. Lift the bolt up about 1", press backward about 1/2" and lift bolt and striker assembly out and forward. (fig. 5).
 2. Remove the striker assembly by pulling rearward.
- NOTE: Do not remove the spring attached to the striker assembly.
3. Remove bolt return spring assembly.

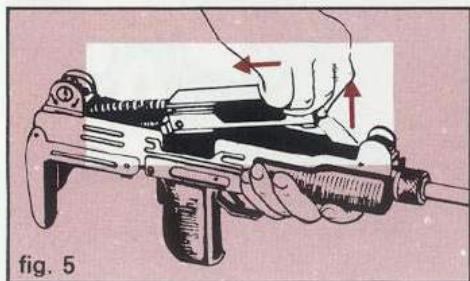

16

ASSEMBLING THE BOLT AND THE STRIKER ASSEMBLY

1. Insert striker assembly and the bolt return spring assembly into bolt. (fig. 6).
2. Holding entire assembly (with

striker on bottom), guide return springs into their respective seats in the buffer (at rear of receiver).

cont. ▶

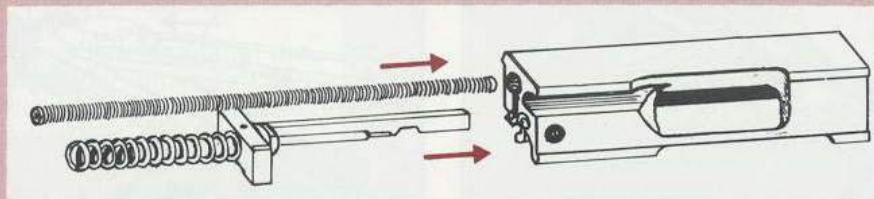
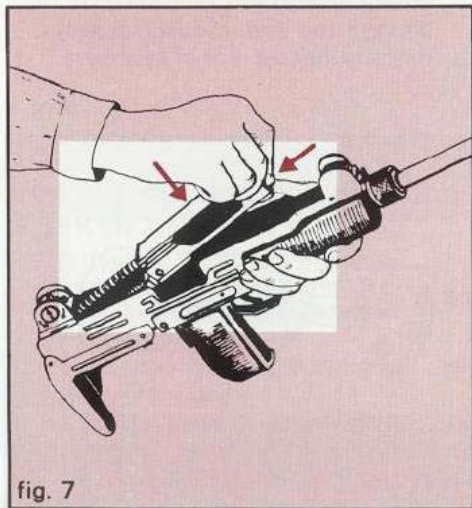

fig. 6

3. Pull bolt backward (about 1/2") and lower it into receiver (fig. 7).
NOTE: Do not force.



ASSEMBLING RECEIVER COVER

1. Insert front end of cover (narrow end) in recess under front sight (fig. 8).
2. Lower rear end of cover until it rests on top of the latch.
3. Firmly press rear end of cover until catch snaps into place.
4. Check that catch is fully forward.

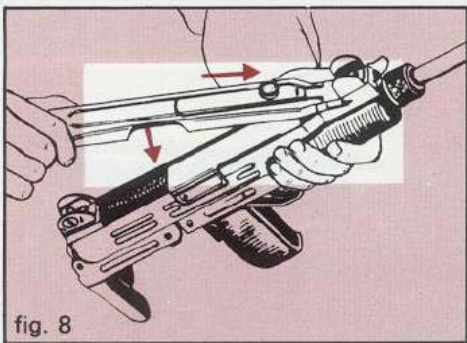

18

DISASSEMBLY AND ASSEMBLY OF THE MAGAZINE

DISASSEMBLING

WARNING: Magazine spring is under pressure and can fly out and cause injury if not held in place during assembly and disassembly. Do not point magazine base toward face or other person.

1. Before disassembling the magazine, remove all cartridges.
2. Hold magazine with base facing upwards.
3. With the aid of a small pointed object, push base catch inward (fig. 9).
4. With catch depressed, carefully push magazine base forward approximately 1/2" **cont.** ▶

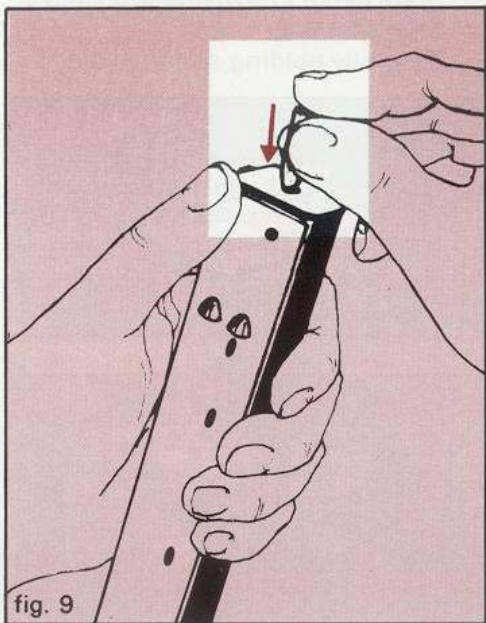

19

(until catch protrusion is visible at edge of base).

5. Carefully holding spring in place

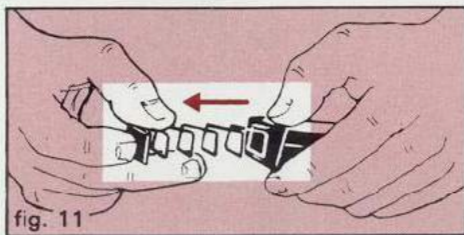
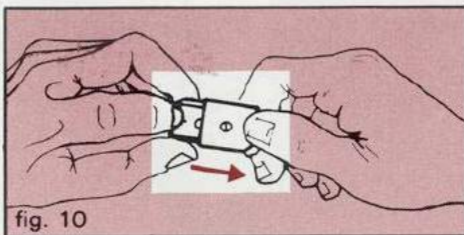

with index finger, remove magazine base (with other hand). (fig. 10).

6. Using both hands, ease spring and follower out of housing (fig. 11).

ASSEMBLING

1. Hold magazine with lips downward, slots facing away from you.
2. Insert follower with legs up and long leg to your right, and drop into place. Do not force.
3. Hold spring vertical with catchup so that catch is higher on the right side.
4. Insert spring into housing.
5. Compress spring so that catch is slightly below housing bottom.
6. While holding spring with index finger, insert base with square edge facing magazine and push home until catch locks.

20

OPERATING INSTRUCTIONS

STOCK UNFOLDING

1. Grip carbine in left hand, under trigger guard, barrel facing left.
2. Strike butt plate with palm of right hand in a downward and forward

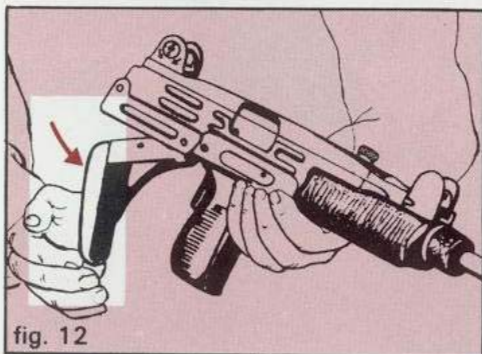

direction. The butt will disengage from its catch. (fig. 12).

3. Grasp butt plate and pull rearward until stock locks. (fig. 13).

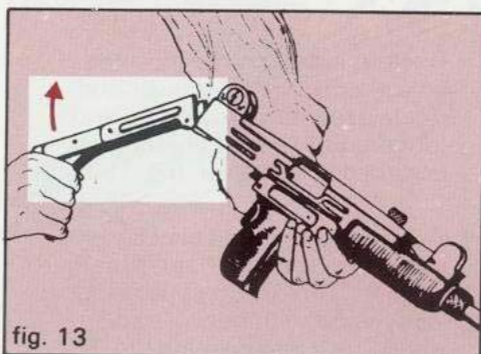

21

FOLDING

1. Grasp carbine under hand guard.
2. Press right rear side plate inward, adjacent to hinge pin and rotate rear section upward and forward. (fig. 14).
3. Press in locking button located adjacent to rear of receiver and rotate assembly downward and forward until assembly contacts underside of receiver. (fig. 15).
4. Rotate carbine until pistol grip faces upward with hand in center of cover. Strike butt plate firmly downward with heel of hand snapping it into position (fig. 16).

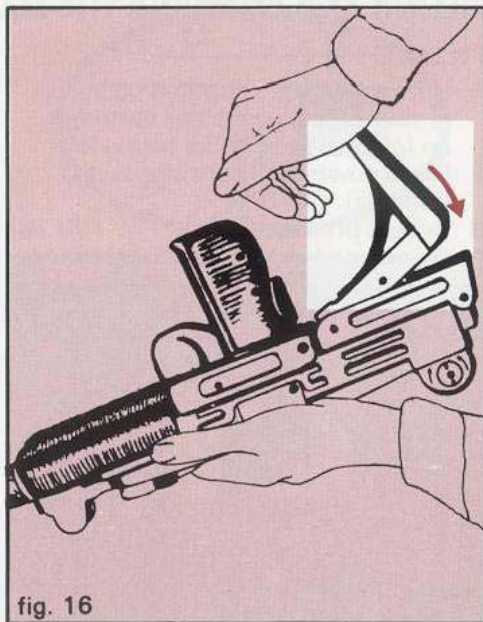
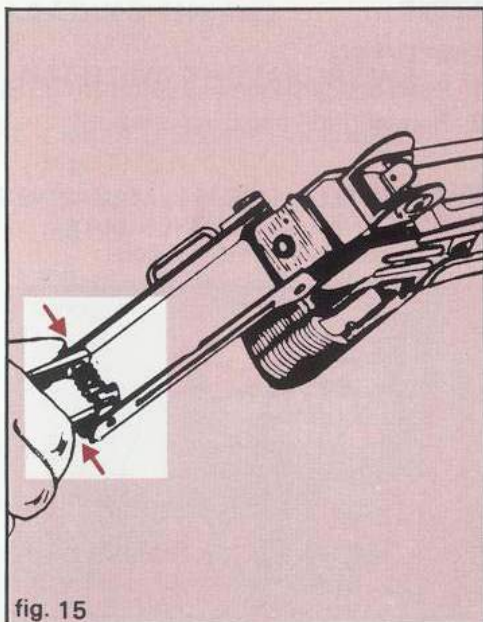
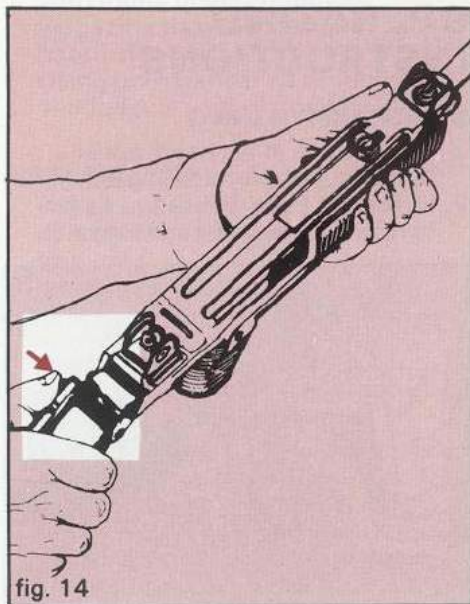

FILLING AND EMPTYING THE MAGAZINE

FILLING

1. With magazine in upright position & slots facing you, place cartridge on follower with bullet facing left.
2. Press down until cartridge snaps under lip. (fig. 17).
3. Repeat until loaded.
4. Do not load more than 25 cartridges.



EMPTYING

1. Push out cartridge with thumb (fig.18).
2. Repeat until magazine is empty.

WARNING: USE I.M.I MAGAZINES ONLY. OTHER MAGAZINES MAY CAUSE FEEDING PROBLEMS.



24

LOADING THE UZI

INSERTING THE MAGAZINE

1. Clear the carbine. (see page 27 Nos. 1-7).
2. Set the fire selector on "S" (Safe). (fig. 19).
3. Grasp pistol grip with right hand, trigger finger outside of trigger guard.
4. Tilt the carbine to the right, and insert the magazine into the pistol grip opening with your left hand. Push until magazine catch snaps into place. (fig. 20).

WARNING: Do not insert a loaded magazine when short (display) barrel is installed.

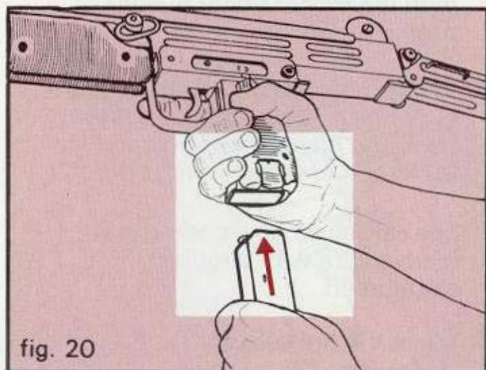
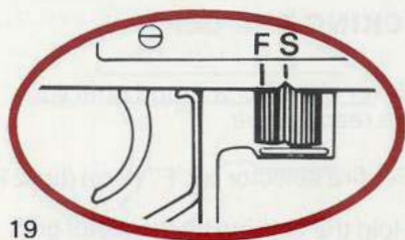

25

COCKING THE UZI

1. Never chamber a round until you are ready to fire.
2. Set fire selector to "F" (Fire) (fig. 21).
3. Hold the carbine by the pistol grip, with the trigger finger outside of trigger guard.
4. While fully depressing the safety grip, pull cocking knob all the way back and release knob instantly to allow bolt to snap forward. (fig. 22).
5. The carbine is now cocked and ready to fire with a round chambered.
6. Move the fire selector to "S" (Safe). (fig. 23).

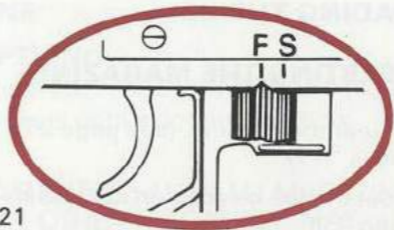

fig. 21

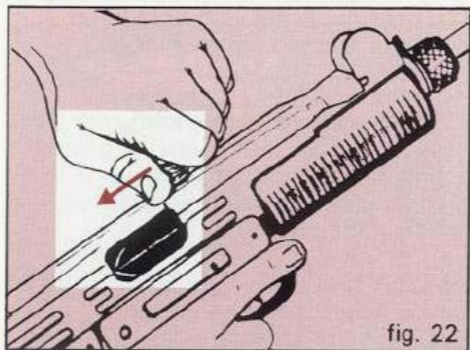

fig. 22

26

UNLOADING (CLEARING) THE UZI

1. Place fire selector on "S" (Safe). (fig. 23).
2. Depress magazine catch and remove magazine (fig. 24).
3. Place fire selector on "F" (Fire) and cock bolt to remove live cartridge in chamber. (see page 26).
4. Holding bolt in the rear position, look into chamber to ensure that chamber is empty.
5. If chamber is not empty, release bolt and repeat steps 3 & 4. If, after repeating twice, chamber is not empty, refer to Trouble Shooting. (see page 40).
6. With chamber empty, release bolt and squeeze trigger with barrel pointing in safe direction.
7. Place fire selector on "S" (Safe).
8. Empty magazine. (see page 24).



fig. 23

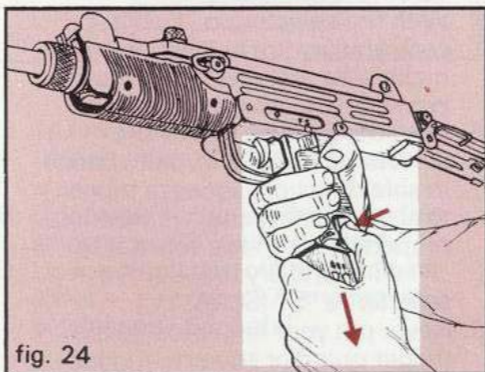

fig. 24

27

PRECAUTIONS BEFORE FIRING

1. Before firing, always wear eye and ear protection.
2. Ensure that the stock is unfolded and there is no magazine in the carbine.
3. Before firing, ensure barrel is dry, clean, free of obstructions and carbine is unloaded.
4. With fire selector on "F" (Fire), cock and dry fire at least twice to make sure that the mechanism is working smoothly and properly.
5. Cock the carbine, return fire selector to "S" (Safe), point barrel in safe direction, squeeze trigger to ensure safety catch is working properly. Return fire selector to "F" (Fire) and dry fire. Set fire selector to "S" (Safe).
6. Never put your finger inside the trigger guard or squeeze trigger

- unless you are ready to fire. From the time that the magazine is inserted, until carbine is cleared and clearance checked, keep carbine pointed in a safe direction.
7. Fire selector should always be on "S" (Safe) until you are ready to fire.
8. Check that magazines are clean and properly loaded.

AIMING AND FIRING

1. Unfold the stock, (see page 21).
2. After loading the carbine as previously described, place rear sight at required range, 1 (100 m) or 2 (200 m) (fig. 25).
3. Grasp the UZI with one hand on the pistol grip (trigger finger outside of trigger guard) and the other hand on handguard.
4. Raise carbine and pull stock firmly into shoulder.

28

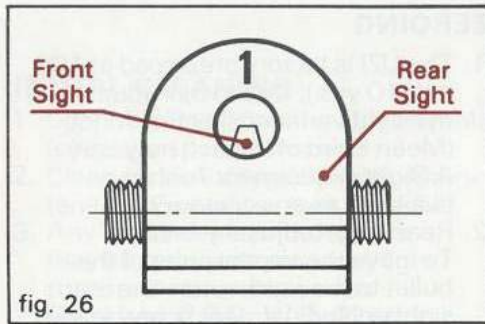
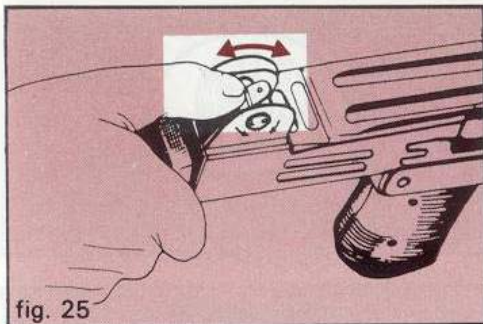

5. Line up your sights with your target by placing the top of the post in the center of the rear aperture. (fig. 26).
6. Move fire selector to "F" (Fire), place trigger finger on trigger and squeeze until carbine fires. SAFETY GRIP MUST BE FULLY DEPRESSED.

7. To fire subsequent rounds, release trigger and pull it again for each shot.
8. Upon interruption of firing, set fire selector on "S" (safe) position.
9. Upon completion of firing, unload (clear — see page 27) and set fire selector on "S" (Safe).

29

ZEROING

1. The UZI is factory prezeroed at 100 m (110 yds.). Due to individual eyesight variations, actual M.P.I. (Mean Point of Impact) may vary. A Sight Adjustment Tool is available as an accessory.
2. Rear Sight (adjusts windage)
To move the impact point of the bullet to the right, rotate the rear sight and adjustment screw to the right. (clockwise). One click will move the impact point of the bullet to the right 1 cm. (0.4") at 25 m (27.5 yds.) (fig. 27).
3. Front Sight (adjusts elevation)
To move the impact point of the bullet up, rotate the front sight post to the right (clockwise). One click will move the impact point of the bullet up 1 cm. (0.4") at 25 m (27.5 yds.) (fig. 28).

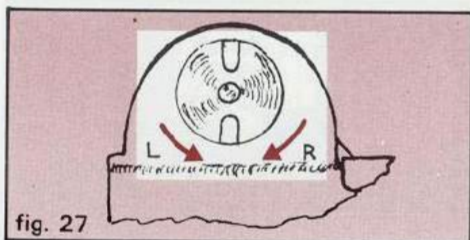

fig. 27

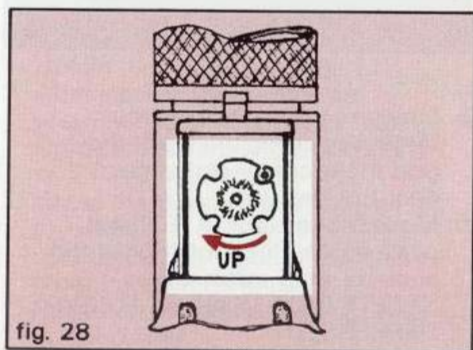

fig. 28

30

CARE AND CLEANING

GENERAL

Comprehensive knowledge of how to service and handle carbines is of great importance. Experience has shown that most failures which occur while operating the carbine are due to negligence in maintenance. Special attention must be paid to cleaning, lubricating and inspecting the carbine; this will determine whether or not the carbine will function properly when you need it. In order to maintain accuracy, the barrel must be serviced thoroughly. The receiver, the bolt assembly and other moving parts of the carbine must be kept clean and lightly lubricated to ensure proper operation. Care and cleaning includes the magazines, which must be kept free from rust, grit, etc., in order to function properly.

INITIAL CLEANING

1. Upon receipt of carbine, disassemble (see page 14) and inspect.
2. Clean carbine as per Periodic Maintenance Procedure. (see page 32).
3. Any heavy or gummy deposits may be removed using very light rust preventive oils such as Breakfree, C.B.C., W.D. 40 or similar. After cleaning, wipe dry and lightly coat with gun oil.
4. Never use abrasive or metallic objects, synthetic cloth, dry cleaning fluids, detergents, acids, lyes, water or steam.
5. Reassemble and make sure proper functioning of carbine and safeties. (see page 33).
6. Observe all safety precautions (see pages 4 and 5).

PERIODIC MAINTENANCE

1. Disassemble the carbine. (see page 14). Clean all disassembled parts as explained below. Remove all foreign matter or dirt using any widely distributed gun oil and gun cleaning equipment made for sporting and hunting firearms.
2. Clean the barrel bore and chamber: use cleaning rod or pull through with a patch. Continue until patches come out clean. After cleaning, lightly lubricate the bore and chamber with a patch dipped in lubricant to prevent corrosion and pitting.
3. Clean exterior and interior surfaces of all subassemblies to remove dampness, dirt and perspiration. Then wipe all metal surfaces with a lightly oiled patch or rag. Pay particular attention to all parts of the firing mechanism.
4. While cleaning, the following inspection must be carried out:
 - a. Examine the bore and chamber visually and make sure it is free of rust, pitting and metal fouling, and that the barrel has not been damaged.
 - b. Check that all disassembled parts are serviceable and none are missing.
 - c. Grasp receiver by pistol grip with fire selector on "F" (Fire), squeeze trigger slowly, two to three times (grip safety fully depressed). Sear should depress and snap back without hangup.
 - d. Inspect the firing pin visually to make sure that it is undamaged. It is normal for the firing pin to be loose in the carrier.
 - e. Inspect extractor visually and make sure it is clean and undamaged.

32

5. Assemble the carbine. (see page 14).
6. After assembly check the following:
 - a. Make sure the chamber is empty.
 - b. With fire selector on "F" (Fire) position, cock and dry fire at least twice to make sure that the mechanism is working smoothly & properly.
 - c. Cock the carbine, move fire selector to "S" (Safe), point barrel in safe direction, squeeze trigger to make sure safety catch is working properly. Return fire selector to "F" (Fire) position and dry fire. Set fire selector to "S" (Safe).
 - d. Check sights and all exterior parts of the carbine to make sure that they are undamaged and serviceable.
7. It is imperative that magazines be given the best of care and kept in

perfect condition. They should be disassembled, cleaned, and lightly oiled. (see page 19). Check magazine lips. They should not be deformed or nicked.

CLEANING BEFORE FIRING

1. Disassemble the carbine. (see page 14).
2. Run clean patches through bore and chamber to remove all dust and oil. There should be no oil in bore and chamber before firing as this may cause dangerous pressures to develop.
3. Remove excess oil from interior of bolt and bolt face.
4. Check that all moving parts are lightly oiled.
5. Assemble the carbine and check functioning. (see page 28).

33

CLEANING AFTER FIRING

1. The carbine should be cleaned not later than the evening of the day on which it was fired to prevent corrosion and caking of deposits.
2. Follow procedures of periodic maintenance and pay particular attention to all parts which have been in contact with powder gases.
 - a. Barrel — In order to remove heavy deposits, use cleaning brush. Make sure the brush goes all the way through the bore before reversing the direction. Deposits that cannot be readily removed with the brush may be treated by coating bore & chamber with good quality bore cleaning fluid and allowing to soak for at least twelve hours.
 - b. Firing Mechanism — Remove all powder residues from bolt face and interior surfaces of bolt. If necessary, use stiff nylon brush or tooth brush. Remove extractor and clean caked deposits at least once every 1000 rounds. (see page 36). Clean and lightly oil all parts of bolt and striker mechanism.
 - c. Receiver — Wipe off any heavy deposits in interior and oil lightly.
 - d. Magazine — Make sure magazines are clean and follower moves freely.

34

ADDITIONAL DISASSEMBLY

EXTRACTOR

Extractor should be removed for cleaning after the following:

1. Firing a total of 1000 rounds.
2. Exposure to moisture, water or rust-causing environment.

DISASSEMBLY

1. Using a suitable drift pin ($1/8''$ to $5/32''$ dia.) push out extractor retaining pin from its shank end, holding finger over blocking latch to keep spring from jumping out (fig. 29), then carefully remove blocking latch with spring.
2. Using the retaining pin, push extractor forward and remove from bolt. If extractor is frozen because of excessive carbon

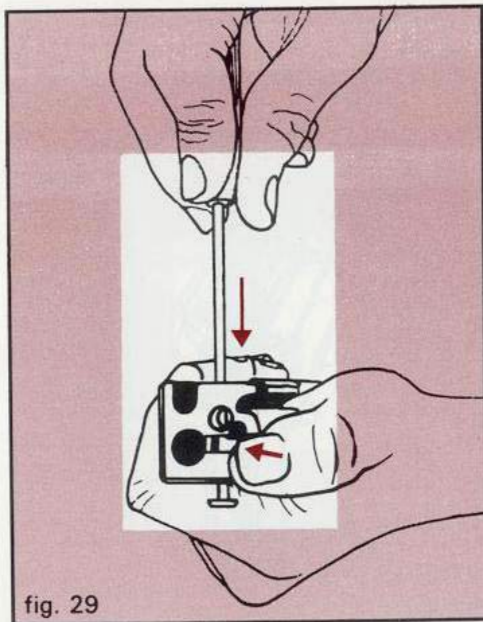
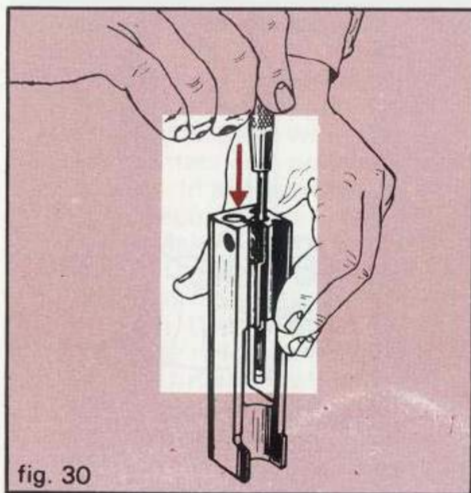

fig. 29

35

deposits, tap forward and out using a suitable drift pin (3/16" to 1/4" dia.) (fig. 30).



CLEANING

1. Remove all caked deposits from extractor claw. Clean and oil lightly.
2. Using a small diameter brush or patch, clean and lightly lubricate extractor hole. (Any .22 caliber cleaning equipment may be used).

ASSEMBLY

1. Hold bolt with rear facing you and ejection port to the right.
2. Insert extractor in bolt from the rear with claw forward and slot in thick end up (fig. 31).
3. Push extractor forward until base is flush with small recess in bolt end. Slot must be parallel to the extractor retaining pin hole (fig. 32).

36

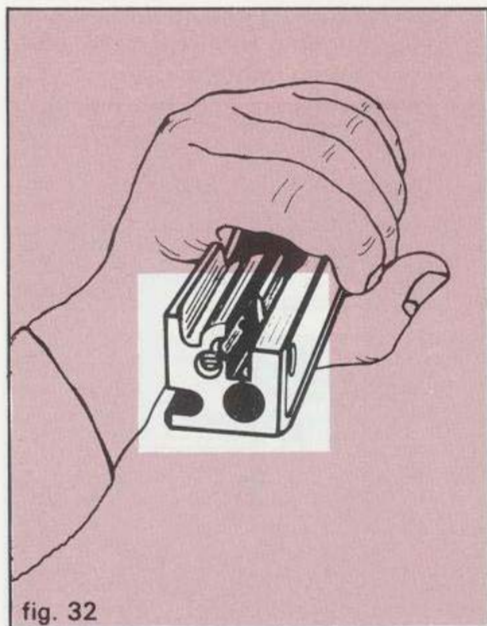
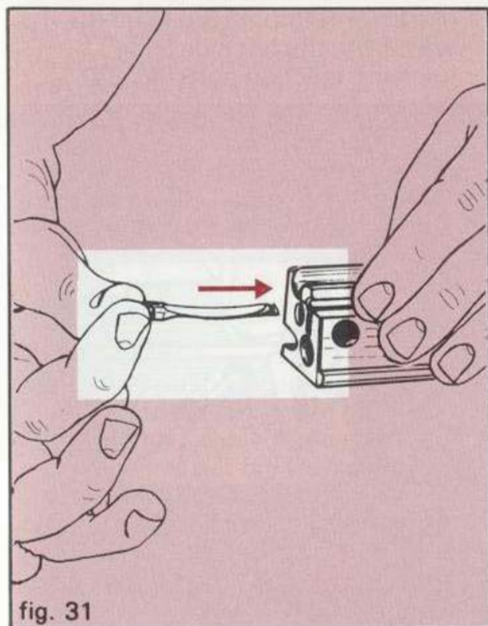

4. Put blocking latch with spring in place, aligning holes (fig. 33): Hold in place with finger and push

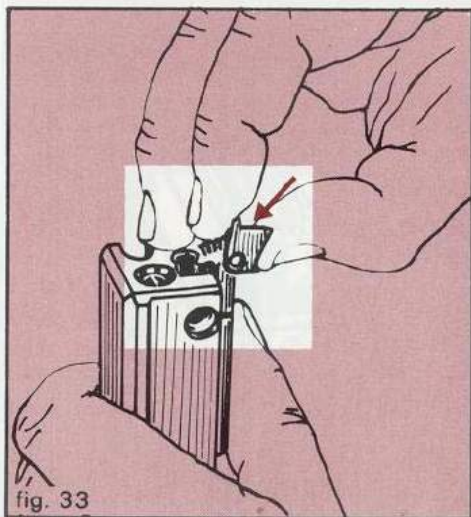

extractor retaining pin in all the way, from the left side (side opposite ejection port) (fig. 34).

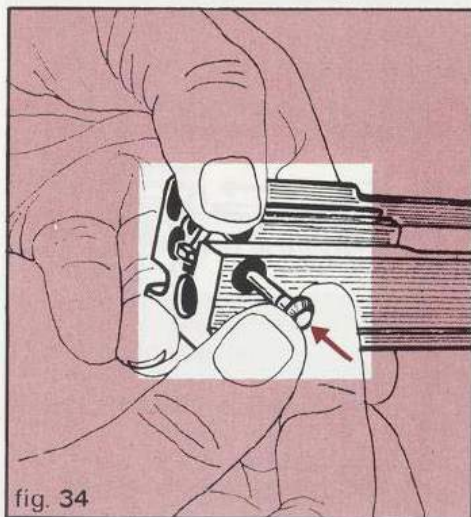

38

PISTOL GRIP

The pistol grip should be disassembled for cleaning and oiling only after any of the following:

1. Firing a total of 5000 rounds.
2. Once a year.
3. Exposure to moisture, water or rust-causing environment.

DISASSEMBLY

1. Partially push out pistol grip pin with a suitable drift pin (approx. 5/16" dia.). Pin should clear lug on receiver but fall free of the pistol grip. (fig. 35).
2. Remove grip from the receiver. (fig. 36).

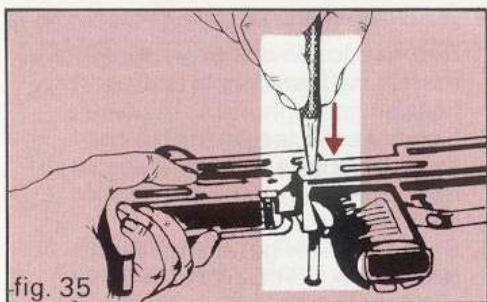

CLEANING AND OILING

1. Remove loose dirt and foreign matter with small parts cleaning brush.
2. Set fire selector on "F" (Fire), squeeze trigger and let sear snap up.
3. Repeat step 1.
4. Spray interior generously with Breakfree, C.R.C., W.D. 40 or similar compound while holding upside down.
5. Let excess drain out.
6. Apply gun oil to all pivot points, moving, or contacting surfaces.
7. Move fire selector back and forth several times to distribute lubricant.
8. With fire selector on "F" (Fire) rotate sears rearward until they snap under disconnecter.
9. Set fire selector on "S" (safe).

ASSEMBLY

1. Insert lip in front of pistol grip into recess at bottom receiver (fig. 37).
2. Press grip safety and bring pistol grip into position on receiver by jiggling slightly. Make sure pistol grip pin hole aligns with hole in lug on receiver.
3. Tap pin into place with a soft hammer or aluminum block.



40

IMMEDIATE ACTION AND TROUBLE SHOOTING

A failure to fire including one caused by an empty magazine, may often be corrected by taking immediate action.

WARNING: USE I.M.I. MAGAZINES ONLY.

IMMEDIATE ACTION

Remove magazine and wait 3 seconds with barrel pointing in a safe direction, then inspect magazine.

1. MAGAZINE EMPTY

Cock to remove possible last round. Inspect chamber and if empty, insert full magazine, recock and continue firing.

2. MAGAZINE NOT EMPTY (Malfunction)

- a. Recock to clear possible defective or wrongly positioned round. If a round or case ejects, inspect chamber and if empty, reload and continue firing.
- b. If nothing ejects, fully draw back bolt and check if a cartridge or case is in chamber. If empty, reload and continue firing.
- c. If base of cartridge is visible, allow bolt to snap home and fire in a safe direction. If carbine fires and ejects, reload and continue.
- d. If carbine does not fire, set fire selector on "S" (Safe) and follow trouble shooting procedure for "spent case or round stuck in chamber". (see page 45).

41

TROUBLE SHOOTING

A. FAILURE TO FEED

— **Carbine jams or closes on empty chamber.**

CAUSE

1. Incorrect Cocking
2. Incorrect Magazine
3. Magazine Improperly Seated
4. Magazine Improperly Loaded
5. Dirty Magazine
6. Damaged Magazine
7. Short Recoil

REMEDY

- Clear jam if necessary and recock. Pull bolt all the way back and let it snap home by itself: don't ride the cocking knob!
- Replace with I.M.I. factory magazine.
- Push magazine home until latch catches.
- a. Seat top cartridge properly
 - b. Check that no more than 25 rounds are in magazine
 - c. Make sure that not less than 3 rounds were loaded in magazine
- Disassemble and clean.
- Replace.
- Clear jam. Check chamber for cleanliness. Check type of ammunition (may be underpowered). Try other currently commercially manufactured 9 mm ammun.

42

8. Double Feed

- a. Inspect for stuck case or cartridge (E).
- b. Check extractor and ejector (D).

B. FAILURE TO CHAMBER

— **Bolt does not fully close and carbine not fire.**

CAUSE

1. Incorrect Cocking
2. Dirty Chamber
3. Defective Ammunition
4. Very Dirty Carbine
5. Defective Return Spring

REMEDY

- Remove magazine. Recock and reload.
- Clean.
- Check for damaged cartridges.
- Check for sluggishness in bolt and firing mechanism. Clean and oil as necessary
- Check for recurrent sluggishness in operation. Check spring assembly for damage. Replace if necessary.

C. FAILURE TO FIRE

— **Striker assembly snaps home but carbine will not fire.**

CAUSE

1. Bolt not Fully Closed

REMEDY

- Follow procedure for incorrect cocking or short recoil (A)

43

- | | |
|---|--|
| 2. Defective Cartridge | Inspect primer. If fully indented discard safely. If not fully indented, check firing mechanism. |
| 3. Dirty Firing Mechanism
Defective Firing Pin
Defective Striker Assembly | Check for sluggishness of operation.
Clean and replace as necessary. |
| 4. Barrel Not Properly Seated | Make sure that the FLATS on the barrel line up with the FLATS on the barrel housing protrusion. Tighten barrel retaining nut until clicking noise stops. |

D. FAILURE TO EXTRACT OR EJECT

— **The bolt may not fully recoil, the fired case may not eject, or the carbine may jam (spent case left in chamber).**

CAUSE

1. Underpowered Ammunition (Short Recoil)
2. Dirty or Damaged Chamber

REMEDY

- Check ammunition and change to a different brand of currently commercially manufactured 9 mm ammunition if problem persists.
- Inspect, clean, replace barrel if necessary

- | | |
|-----------------------------------|---|
| 3. Defective Ammunition | Check ammunition for damage. Replace if problem persists. |
| 4. Fouled Extractor | Clean Extractor. |
| 5. Extractor Defective or Missing | Replace |
| 6. Damaged Ejector | Replace if necessary. |

E. SPENT CASE OR ROUND STUCK IN CHAMBER

CAUTION: The following procedure should be carried out only after following the steps in "Immediate Action". (see page 41—2b, c, d).

1. Remove bolt and striker assembly.
2. With barrel in place, insert cleaning rod through front of barrel. Push or tap gently to remove obstruction.
3. Check chamber and bore. Clean before reassembly.
4. If obstruction cannot be removed, disassemble barrel and contact authorized service station.

WARNING!

IT IS DANGEROUS TO ALTER OR MODIFY THIS FIREARM IN ANY WAY. ANY ALTERATION OR MODIFICATION OF THE FIRING MECHANISM MAY RESULT IN THIS FIREARM BECOMING UNSAFE. ANY ATTEMPT TO ALTER OR MODIFY THIS FIREARM IS ILLEGAL AND WILL NULLIFY ALL WARRANTIES AND WILL BE SUBJECT TO IMMEDIATE NOTIFICATION OF APPROPRIATE FEDERAL LAW ENFORCEMENT AGENCIES.



FOLDED STOCK



EXTENDED STOCK



WOOD STOCK

68.1.2007 29.8.10.8003

SEPTOGRAPH PRINTED IN ISRAEL



ISRAEL MILITARY INDUSTRIES

P.O.B. 1044, Ramat Hasharon 47100, ISRAEL



action arms ltd.

P.O. BOX 9573 - PHILADELPHIA, PA 19124 U.S.A. TEL (215) 744-0100