



Winchester Supreme Over/Under Shotgun Owner's Manual

Important instructions for

Winchester Supreme Over/Under Shotgun

Customer Service Department (United States)

U. S. Repeating Arms Company, Inc.

275 Winchester Avenue

Morgan, Utah 84250-9333

Phone: 1-800-945-5237

If you have any questions or comments regarding your new firearm, please feel free to write or call us. Use the space below to record information about your new firearm.

Model _____

Serial Number _____

Purchased From _____

Date of Purchase _____

Winchester trademarks derived from Olin Corporation
©2010 U.S.A. 1001010015

Contents	Page
Gun safety warnings	1
General description	2
General operation	3
Terminology and descriptions	5
Serial number	5
Ammunition	5
Initial cleaning/oiling	9
Operation of the safety	10
Travel selection	11
Assembly	12
Disassembly	14
Loading procedures	16
Unloading procedures	18
Firing procedures	20
In the case of a misfire	21
Invector® Plus choke system	21
Changing length of pull (special models)	24
Cleaning and maintenance suggestions	25
Parts, service, repair and questions	26
Winchester-guns.com	28

GUN SAFETY WARNINGS

IT IS ESSENTIAL THAT THESE OPERATING INSTRUCTIONS BE THOROUGHLY STUDIED BEFORE USING THIS FIREARM TO ASSURE PROPER AND SAFE GUN HANDLING. FAILURE TO FOLLOW THESE INSTRUCTIONS OR FAILURE TO OBEY ANY SAFETY WARNING MAY RESULT IN INJURY TO YOURSELF OR OTHERS, OR CAUSE DAMAGE TO YOUR GUN.

As a gun owner, you accept a set of demanding responsibilities. How seriously you take these responsibilities can be the difference between life and death. There is no excuse for careless or abusive handling of any firearm. At all times handle your Supreme shotgun and any other firearm with intense respect for its power and potential danger.

PLEASE READ AND UNDERSTAND ALL OF THE CAUTIONS, PROPER HANDLING PROCEDURES AND INSTRUCTIONS OUTLINED IN THIS BOOKLET BEFORE USING YOUR NEW FIREARM

1. Do not carry a loaded gun with a live round in the chamber while walking, running, climbing a tree, crossing a fence or anywhere you might slip or fall, drop the gun, or otherwise bump or jar the gun. A gun that is dropped, bumped, or jarred with a chambered round might accidentally discharge even with the safety on, causing serious

injury to you or someone else. When a round is chambered keep the safety on until you are ready to shoot.

2. Do not rely on the safety to prevent accidental discharge. Many safeties merely block the trigger and prevent firing by pulling the trigger. The safety may not prevent an accidental discharge due to dropping, jarring, or bumping a gun.

3. Use only ammunition for which the gun is chambered as indicated on the barrel, to prevent excessive pressure and possible serious personal injury.

4. Incorrectly reloaded ammunition can cause serious personal injury and damage to the firearm due to excessive pressure. Reload only after proper instruction and in strict compliance with instruction and data contained in current reloading manuals.

5. Never point a gun at anything you do not intend to shoot. Always keep it pointed in a safe direction in case of accidental discharge.

6. Always check to ensure that the barrel is free of obstructions before loading and using the gun. If you experience light recoil or off sound, check the barrel for an obstruction.

7. Before firing, clean any grease or oil out of barrel with cleaning rod and patch. Grease or heavy accumulation of oil can cause excessive pressure and result in serious personal injury.

8. Keep barrel, chamber and action free of rust. Rust in the barrel and chamber can cause excessive pressures resulting in serious injury. A rusted, pitted or eroded barrel should be replaced.

9. Use hearing protection to prevent ear damage from repeated exposure to gunfire.

10. Always use proper shooting glasses to prevent eye injury from flying particles.

11. Never carry a loaded gun in a motor vehicle or carry one into a dwelling. Always carefully unload the gun before entering a motor vehicle, a dwelling or an area such as a camp. Always point a gun in a safe direction while loading or unloading to prevent serious injury in case of an accidental discharge. Never load in the house or in your vehicle.

12. Never shoot at a hard, flat surface or at the surface of water to avoid a ricochet and possible serious personal injury to yourself or a bystander.

13. Store gun in a clean dry place out of reach of children and separated from stored ammunition.

14. Never alter any parts of your gun. Any alterations or

adjustments that may become necessary to the operating mechanism should be performed by a qualified gunsmith.

15. Hunting from elevated surfaces such as tree stands is dangerous. Doing so may increase the risk of handling any firearm. Always make certain that the stand being used is safe, sturdy and stable. Always make certain your firearm is unloaded when it is being taken up and down from the stand. Always make certain that your firearm is not dropped from the stand or dropped while it is being taken up or down from the stand.

16. Discharging firearms in poorly ventilated areas, cleaning firearms, or handling ammunition may result in exposure to lead and other substances known to cause birth defects, reproductive harm and other serious physical injury. Have adequate ventilation at all times. Wash hands thoroughly after exposure.

GENERAL DESCRIPTION/OPERATION

Balance, Portability, Reliability, Handling. There are what you expect in an overlander, and they're what you get with your new Winchester Supreme. It's superbly designed, combining the best traditions of American hunting guns and European competition guns. Supreme Field models are ready for many years of brisk Nebraska pheasant hunts to dusty Texas quail hunts to New England grouse hunts accented by bright fall colors.

Handling is its key advantage with a lively feel and dimensions designed so you can quickly acquire and move to target.

Sporting models are true competition overunders from Winchester. A great sporting clays shotgun begins at the receiver. The Supreme's low-profile receiver with dual, between-the-barrel locking is the foundation. This, combined with stock dimensions designed to put you on target consistently, brings the package together. It's the right design. The right dimensions. The right balance. The right shotgun for serious sporting clays competitors.

A few things to take notice of are:

- **Low-profile receiver.** The perfect receiver design for the optimal combination of action strength, pointability and balance.
- **Strength is important.** The Supreme features dual locking pins — made to stay tight under years of heavy use.
- **Invector Plus.** This is the same choke system found on today's leading sporting and hunting guns world-wide. The longer tubes, combined with back-cored barrels, reduce shot deformation and produce consistent, tight patterns across the entire choke spectrum. (Your choke tubes may be marked "Win-Plus.") However, there is no difference.
- **Barrel selector.** The selector is integrated into the top tang safety. You can select which barrel fires first and the

other barrel fires with the next pull of the trigger.

In order to keep your new shotgun in top condition and operating at its peak performance you must read, understand and follow all of the instructions in this manual.

GENERAL OPERATION

The Supreme is an over and under shotgun design made to fire two successive shots by pulling the trigger twice once for each shot, each time the action is broken open the hammers are cocked automatically. Each time the action is opened empty shells (one or two) are ejected clear of the chamber(s) automatically. Unfired shells are elevated in the chamber. They can be left in place or removed with your fingers. The action is broken open with a lever mounted on the top of the receiver just forward of the safety switch. The Supreme breaks down into three pieces in just seconds for cleaning or storage.

Before using live ammunition, familiarize yourself thoroughly with all the operating instructions in this manual. Get accustomed to the feel of your new gun. Know the forces required to operate the action. Understand how to select the firing order of the barrels. Learn how to pull the trigger correctly, and above all, know the location and operation of the safety. Procedures for disassembly and operation of various components are outlined in the sections below. Please read and study them thoroughly.

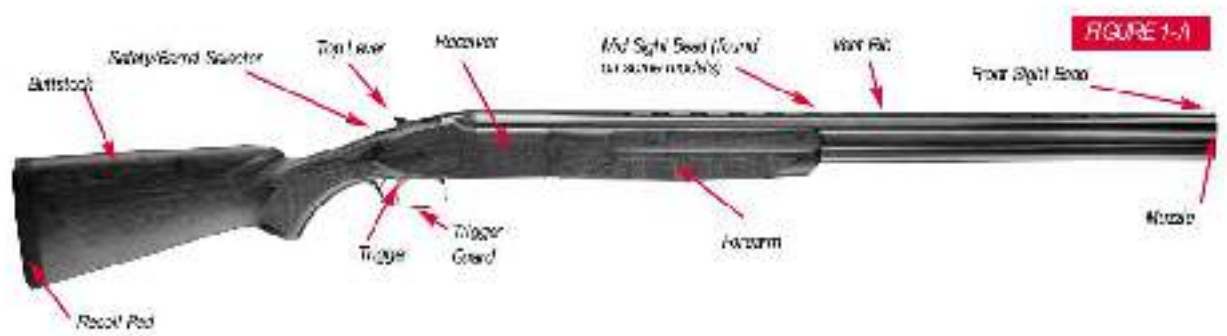

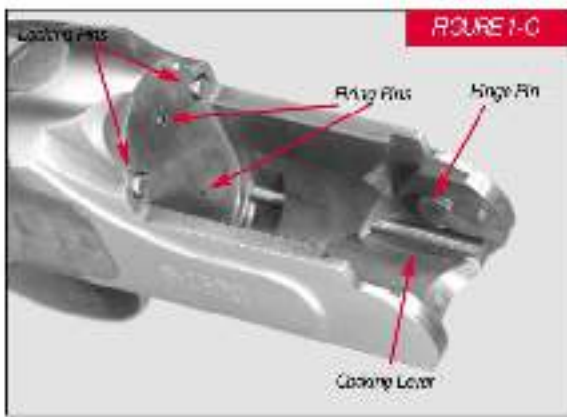

In addition, always remember:

IMPORTANT: ALWAYS KEEP THE MUZZLE POINTED IN A SAFE DIRECTION.

USE THE CORRECT AMMUNITION AS REFERENCED BY THE INSCRIPTION ON THE BARREL.

BEFORE LOADING YOUR GUN BE SURE ALL GREASE AND OIL HAVE BEEN REMOVED FROM THE BARREL AND CHAMBERS, AND THERE ARE NO OBSTRUCTIONS.

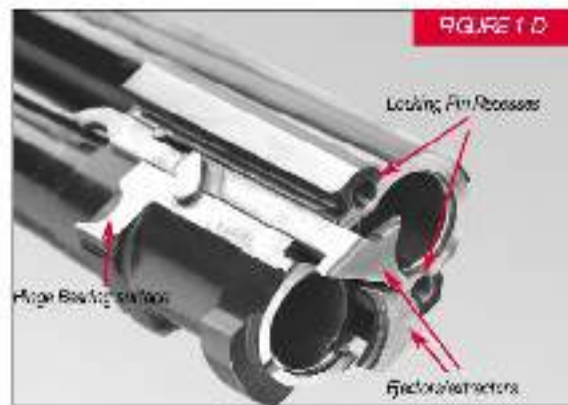

TERMINOLOGY AND DESCRIPTIONS

Descriptions in this manual generally refer to the gun in the horizontal position. That is, in the normal firing position. For example, the muzzles are forward or front; the butt stock is rearward or rear; the trigger is downward or underneath; the sight plane is upward or on top. For general parts terminology, refer to Figure 1-A.

The Winchester Supreme is also shown disassembled to the extent necessary in order to follow instructions contained in this book (See Figure 1-B). Details of the action are also shown (See Figures 1-C and 1-D).

(Continued on page 8)

SUPREME FEATURES

The top tang safety offers excellent convenience with both gloved and ungloved fingers. Plus, it is ambidextrous for right or left-handed shooters.

The Supreme has a very compact, low profile receiver with an ideal combination of action strength and balance. The receiver is quick and direct, not too small and not too bulky.

Stocks are profiled for ideal fit, feel, bending and lower recoil on the face.

Optimal recoil pad for maximum comfort.

On sporting models the trigger is adjustable for length of pull.

The dual locking pins are located right between the barrels, one on each side — mechanically light under years of heavy use. The pins are longer and sturdier than some competitive models. This optimizes strength of the action while allowing an overall lower profile of the receiver that found no same other overlanders.

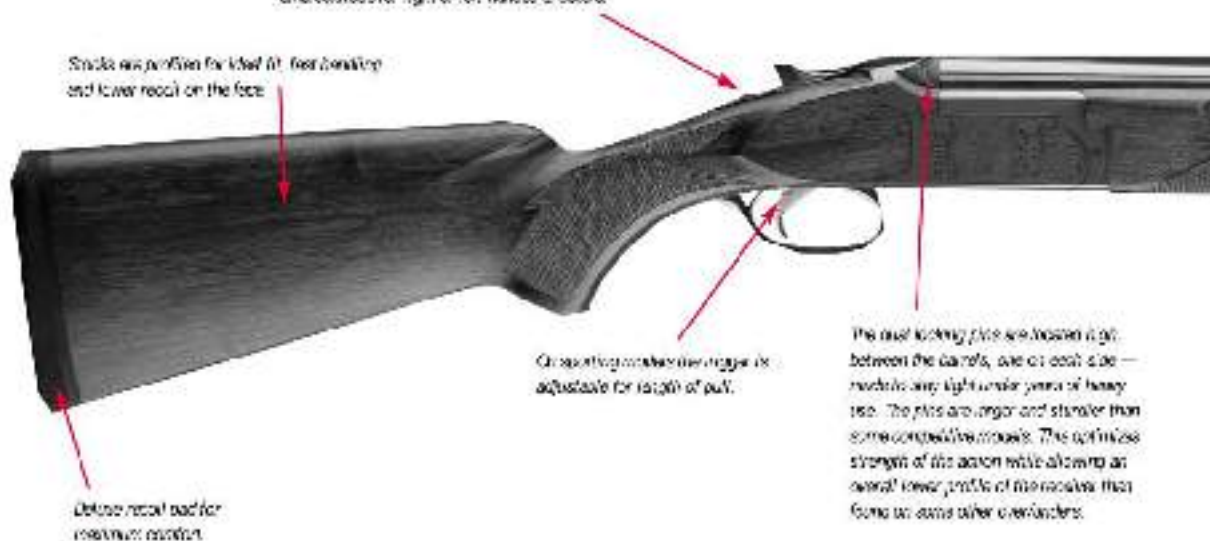

FIGURE 2

The barrel is back-bored for improved pattern performance. Back-boring means that the barrels are made with a slightly larger inner bore diameter than nominal dimensions. This results in less resistance to the shot column as it moves down the bore and less distortion of pellets as they move through the firing zone. There is also a slight increase in powder mass.

Supremes feature a durable, traditional rib design in both field and spacing widths.



The barrels and forearms remove for easy cleaning and storage.

Supreme models are fitted with the proven Invector Plus choke system. These longer tubes have special tapers for optimum patterning — plus they are specially designed for back-bored barrels. It allows you to change choke configurations to cover the demands of the game being hunted or target shot. One full choke tube is available for hunting turkey or other game requiring extremely tight patterns with lead alloy loads.

When empty shells are ejected from a Supreme they land in the chamber at virtually the same time, flying side-by-side through the air. This is a sign of a very well-timed mechanism.

Figure 2 covers the general features and benefits of the Supreme design.

Throughout this manual the "action" refers to the mechanism of this shotgun that secures the shell in the chamber.

SERIAL NUMBER

The serial number is located on the top tang of the receiver under the top lever. A duplicate number is located on the bottom of the barrels (when removed) on the flat surface crossing the barrels below the hinge bearing surface. Record the serial number at the front of this manual for future reference.

AMMUNITION

There are several different versions of the Supreme. The gauge and chamber length are inscribed on the side of the barrel, forward of the receiver. They are inscribed as follows on the receiver:

- **2 3/4" and 3" Magnum.** These models are designed to shoot all factory loads from 2 3/4" up to 3" Magnums. The chamber is designed to accept up to 3" factory loads. (It is not designed to shoot 3 1/2" shells.)
- **2 3/4".** Supreme shotguns with this designation are mainly target models. They are specifically configured to be able to handle all factory 2 3/4" loads including the

lightest target loads up to heavy 2 3/4" hunting field loads. (2 3/4" Target models are NOT designed to shoot 3" or 3 1/2" shells.)

Take extreme care to note the gauge of your shotgun as inscribed on the side of the barrel. You must shoot only shells of the correct gauge. For example, inadvertently placing a 20 gauge shell in a 12 gauge gun is extremely hazardous. The 20 gauge shell can slide forward through the chamber. The rim of a 20 gauge shell will stop when it comes in contact with the end of the 12 gauge chamber (an area called the forcing cone). It is possible for the shooter to think that the chamber simply is not loaded and then insert a 12 gauge shell over the top of the 20 gauge shell. When the 12 gauge shell is fired this will cause the barrel to burst, destroying you, gun and possibly causing serious injury to yourself or others.

Never mix shells of different gauges in hunting clothes or other gear. Train young shooters about the importance of using the correct ammunition for any gun.

MAKE SURE YOU USE ONLY THE EXACT AMMUNITION/GAUGE AS LISTED ON THE LEFT SIDE OF THE BARREL.

U.S. REPEATING ARMS COMPANY, INC., CAN ASSUME NO RESPONSIBILITY FOR INCIDENTS WHICH OCCUR THROUGH THE USE OF CARTRIDGES OF NONSTANDARD DIMENSION OR THOSE THAT WHEN



SHOT, DEVELOP PRESSURES IN EXCESS OF INDUSTRY STANDARDS ESTABLISHED BY THE SPORTING ARMS AND AMMUNITION MANUFACTURERS' INSTITUTE (SAAMI).

DISCHARGING FIREARMS IN POORLY VENTILATED AREAS, CLEANING FIREARMS, OR HANDLING AMMUNITION MAY RESULT IN EXPOSURE TO LEAD AND OTHER SUBSTANCES KNOWN TO CAUSE BIRTH DEFECTS, REPRODUCTIVE HARM AND OTHER SERIOUS PHYSICAL INJURY. HAVE ADEQUATE VENTILATION AT ALL TIMES. WASH HANDS THOROUGHLY AFTER EXPOSURE.

Incorrectly reloaded ammunition can cause serious personal injury and damage to the firearm due to excessive

pressure. Reload only after proper instruction and in strict compliance with instructions and data contained in current reloading manuals.

Winchester ammunition is always an excellent choice for your new Winchester firearm, delivering the unmatched performance and dependability you want.

INITIAL CLEANING / OILING

Some metal parts of your new Supreme have been coated at the factory with a rust preventative compound. Before using your Supreme, clean the anti-rust compound from the inside of the barrels, receiver area, locking pin mechanism, extractor/ejectors, hinge surfaces and the chamber areas. A high quality, lightweight gun oil should be used to remove this compound and to give your new gun its first lubrication. Clean the barrels using a cleaning rod and patch as explained under "Cleaning and Maintenance Suggestions" found later in this manual.

If your new Supreme is to be stored for an extended period of time, it is permissible to leave the rust preventative compound in place and keep your Supreme in its box for maximum protection during long-term storage.

Before beginning assembly of your Supreme you should first wipe the mechanism clean and apply a few drops of quality oil on the surfaces shown (see Figure 3).

Avoid applying too much oil. Only a light film is



necessary. Excessive oil should be wiped off, especially in cold weather.

OPERATION OF THE SAFETY

Your new Supreme shotgun is designed with a top tang-mounted safety. It is located just rearward of the top lever on the top tang, convenient for gloved or ungloved fingers. It is operated with the thumb of your rearward hand when holding the gun in shooting position.

- **ON SAFE:** When pulled fully to the rear with your thumb an "S" is exposed at the front of the safety switch. This shows you visually that the safety is in the "safe" position (See Figure 4-A).
- **OFF SAFE:** When the safety switch is pushed fully



forward the "S" is covered by the safety switch. This indicates to you that the safety is in the "off safe" position (See Figure 4-B).

With the safety in the "on safe" position the trigger and hammer are blocked and the shotgun cannot be fired. In the "off safe" position — if your gun is loaded with a round in the chamber — the chambered round can be fired by simply pulling the trigger.

Never rely totally on your gun's safety switch/button. It is merely an aid to safe gun handling. Like any mechanical device the safety can possibly fail; it can be bumped off or inadvertently manipulated into an unsafe condition. Always keep your shotgun pointed in a safe direction.

At all times in the field keep the safety in the "ON SAFE" position and the barrel pointed in a safe direction. It is a good idea never to load your shotgun until you are in the field and shooting is imminent or until you are at your station and it is your turn to shoot when you are shooting at a range. For extra safety, and as a courtesy to others, fully unload and place the action in the open position at all times other than when shooting is immediately imminent.

Note: Do not depend on the exposed "S" alone to indicate your gun's safety status, as time, exposure to the elements, and the abrasive action of cleaning agents may obscure it.

It is essential that you become very familiar with the feel, look and operation of the safety on this shotgun before attempting to load and shoot.

BARREL SELECTOR

The safety switch on the top tang of your gun also serves as the barrel selector. The barrel selector allows you to choose which barrel will fire with the first pull of the trigger. The other barrel will then fire with the second pull of the trigger. The safety must be in the "on safe" rearward position to operate the barrel selector.

On the left side of the safety switch is the letter "U" which stands for UNDER. On the right side is the letter "O" which stands for OVER. The safety itself can be moved to the right or left covering and uncovering the letters.

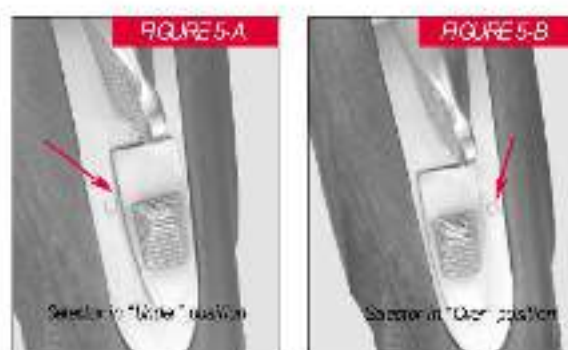

- If the letter "U" is exposed, the under (lower) barrel will fire first. (See Figure 5-A).
- If the letter "O" is exposed, the over (top) barrel will fire first. (See Figure 5-B).

Often different chokes are installed in each barrel which have different constrictions. This may make one choke more preferable for a certain shot. Also there is slightly less muzzle jump when the lower barrel is shot first, making it easier to pick up your target for a follow-up shot. The barrel selector allows you to choose the best choke and firing order combination for whatever conditions you are hunting under or to adapt to the layout of the sporting clays station.



Always make sure that the switch is completely on one side or the other. If the switch is inadvertently positioned directly between "ON" and "OFF" the safety switch may be more difficult to move forward to the "off safe" position. Not only is this aggravating but it may cause you to miss your chance at a bird.

ASSEMBLY

Your new Supreme shotgun will come from the factory partially disassembled in a special box. Remove the barrel assembly (with forearm attached) and receiver/box



section from the carton. Wipe clean and lightly oil component parts as explained under "Initial Cleaning/Oiling."

It is important to carefully follow the assembly instructions below to assure the proper assembly of your shotgun.

Important: These instructions assume you are assembling your Supreme from its disassembled form, exactly as it comes from the factory. The forearm should come attached to the barrel. The buttstock/receiver section and the barrel/forearm section should be two separate components.

BEFORE BEGINNING THE ASSEMBLY PROCESS, ALWAYS MAKE CERTAIN THERE ARE NO SHELLS IN THE CHAMBERS.



1. Inspect the chambers and action areas, and clean dirt and/or excess oil from them as explained in the manual.
2. Remove the forearm from the barrels. To do this hold the barrels with one hand and pull out on the forearm release latch with the other (See Figure 6). Pull the forearm away from the action and entirely off of the barrels. You may need to push it away from the barrels with your fingers on your other hand.
3. Attach the barrels (without the forearm attached to them) to the action by first holding the barrels with the muzzle at a downward angle with respect to the receiver. Then push the top lever to the right. Carefully engage the bearing surfaces



4. of the munition-type pins (located inside the forward portion of the receiver) with the curved bearing surfaces on each side of the bottom barrel (See Figure 7).
4. Once the bearings are properly seated, lift up on the barrels and close the action. Make sure the hinge pins and hinge bearing surfaces remain in proper alignment. When performing assembly procedures it also helps to keep the top lever pushed fully to the right with your thumb until the action is closed (See Figure 8). When the action is fully closed release the top lever and the action will be locked in the closed position.

CAUTION: WHEN CLOSING THE ACTION DO NOT USE UNDUE FORCE.



If the action seems difficult to close, the hinge pins and bearing surfaces may not be properly engaged. Release the upward pressure and carefully separate the barrels from the action again. If forced you may mar and damage the fine fit of your shotgun's action.

5. Once the barrels are installed and the action closed, replace the forearm on the gun by sliding the radiused rear surface of the forearm extension at an angle into radiused front edge of the receiver. The shape of the rear of the forearm should match the shape of the front of the receiver (See Figure 9). When it does, lift the front of the forearm until it engages with the barrels with an audible click. If it does not click, gently slap the forearm just above the latch with the



palm of your hand. If the forearm release latch protrudes after the click, carefully push it into place (See Figure 10). Your Supreme is now fully assembled and the action is closed. Make sure the safety is in the "on safe" position before proceeding.

DISASSEMBLY

Disassembling your Supreme into its two assembly components is an ideal way to ready your shotgun for storage and cleaning. Many luggage-style cases actually require doing this. It is also a way to add an extra measure of safety when storing your gun around the home.

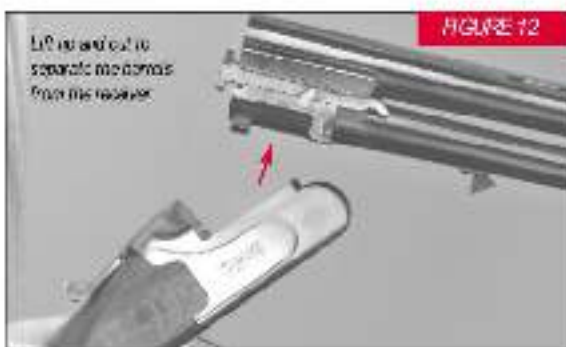

BEFORE STARTING TO DISASSEMBLE YOUR SHOTGUN, ALWAYS MAKE CERTAIN THERE ARE NO SHELLS IN THE CHAMBERS AND THE SAFETY IS IN THE "ON SAFE" POSITION.

1. Open the action by pushing the top lever all the way to the right and pulling the barrels downward to visually make sure the chambers are empty. Once you are sure your shotgun is unloaded, close the action and make sure that the safety is still in the "on safe" position. If not, move it there immediately.
2. Place the butt of your shotgun on your thigh for support. Remove the forearm by pulling outward on the forearm release latch, and pushing the forearm away from the

barrels with the fingers of your other hand (See Figure 11). Pull the front-most end of the forearm away until the forearm can be pulled slightly forward and completely detached from the barrels and the front of the receiver.

3. Separate the barrels from the receiver by holding the stock of the gun securely in your right hand and the barrels in your left. Push the top lever to the right with your thumb. Allow the muzzle of the barrel to drop — the barrels hanging downward from the receiver. Be sure to support the barrels and buttstock carefully while doing this. When the barrels are fully down, carefully lift the hinge portion of the barrels (at the receiver) upward out of the receiver, separating the barrels from the receiver (See Figure 12).

4. If you are cleaning your Supreme this is the ideal level of disassembly. You will have three separate components: 1) the receiver/stock, 2) the barrels, and 3) the forearm. Perform cleaning and maintenance as explained later in this manual.

5. When cleaning is completed, reattach the forearm to the barrels for storage. This is done very easily when the barrels are detached. Simply align the forearm extension along the bottom of the barrel so that the forearm extension aligns with the rails on each side of the chambers.



Make sure the ends of the rails line up with the rear top edge of the forearm (See Figure 13). The forearm can be angled slightly or positioned parallel with the barrels. Press with even pressure using both hands, front to back, along the forearm. As the forearm snaps into position, the release latch will briefly protrude out from the bottom of the forearm then snap down flush with the forearm when it is secured in position correctly.

LOADING PROCEDURES

Before loading your gun, be sure all grease and oil has been removed from the barrel and chamber and there are no obstructions. Use the correct ammunition referenced by the inscription on the barrel. There is only one basic



way to load the chamber of your Supreme.

Before loading the chambers, make sure of the following:

- 1) Your shotgun is pointed in a safe direction.
 - 2) The safety is in the "on safe" position.
 - 3) You are in an appropriate location for shooting.
 - 4) Shooting will be imminent.
 - 5) You have the correct gauge and type of ammunition for your gun.
1. Place the safety in the "ON SAFE" position.
 2. Open the action by pushing the top lever to the right with the thumb of your right hand. (This is assuming your are shooting right handed). Left-handed shooters casually push the lever reaching across with their left thumb.)



3. Visually check to make sure there are not obstructions, grit, grime, oil, cleaning patches or other materials in or around the action area or in the chambers or bores of the barrels.

CAUTION: EVEN THE SMALLEST OBSTRUCTION CAN INCREASE BARREL PRESSURE. THIS MAY RESULT IN BARREL DAMAGE AND SERIOUS INJURY TO THE SHOOTER AND OTHERS IN THE VICINITY.

4. Insert a shell in the chamber or chambers you plan to fire. Make sure they are fully forward in the chamber(s), with the rims in direct contact with the edge of the extractors/ejectors (See Figure 14).

CAUTION: MAKE SURE THE SHELLS ARE OF THE PROPER GAUGE AND CHAMBER LENGTH FOR YOUR GUN. CHECK THE AMMUNITION DESIGNATION ON THE

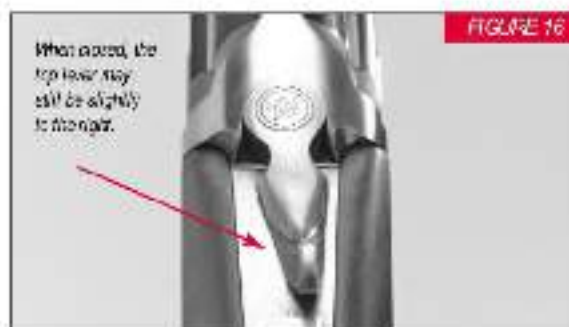

BARREL AND CHECK THE DESIGNATION ON YOUR AMMUNITION. FAILURE TO FOLLOW THESE INSTRUCTIONS CAN RESULT IN SEVERE DAMAGE TO YOUR GUN AND POSSIBLE SERIOUS INJURY TO YOURSELF OR OTHERS.

5. Close the action by lifting up on the forearm, hinging the barrels upward into position, until the action is fully closed. When closed the top lever will snap back into the center position. There should be no space between the face of the barrels and the face of the receiver when the action is fully closed (See Figure 15).

It is common, because of the tight tolerances and craftsmanship of your shotgun, that the top lever will be just slightly right of center, even when the action is fully closed (See Figure 16). This is the result of tight

tolerances which assure your gun of good receiver-to-barrel fit for many years to come and is the sign of a finely crafted firearm.

If the action of your shotgun resists closing, do not force it closed. Small pieces of shell plastic, grit, or other obstructions can make it difficult to close the action. Make sure all surfaces are clean; if an unusual resistance is felt, then try again. If it still resists closing, fully disassemble and perform a thorough cleaning, then reassemble. If you still have a problem, take your Supreme to a qualified gunsmith or to one of the many Winchester Authorized Repair Centers.

6. Select the barrel you want to fire first by operating the barrel selector which is an integral part of the safety switch. The safety must be in the rearward, "on safe" position to be able to select the firing order of your barrels. Refer to the instructions under "Barrel Selection."

IMPORTANT: THE GUN IS NOW READY TO FIRE BY MOVING THE SAFETY TO THE "OFF SAFE" POSITION AND PULLING THE TRIGGER. AFTER FIRING THE FIRST BARREL, THE SECOND BARREL FIRES WITH JUST THE PULL OF THE TRIGGER. IMMEDIATELY PLACE THE SAFETY IN THE "ON SAFE" POSITION IF THE SECOND BARREL WILL NOT BE IMMEDIATELY FIRED.

TO AVOID ACCIDENTAL DISCHARGE: DO NOT CARRY A GUN WITH A SHELL IN THE CHAMBER UNLESS

SHOOTING IS IMMINENT. IN ALL CASES, WHEN FIRING IS NO LONGER IMMINENT, MAKE SURE THE SAFETY IS IN THE "ON SAFE" POSITION.

UNLOADING PROCEDURES

One of the convenient features of an over and under shotgun is how convenient it is to load, unload and determine the safety status of your shotgun. With the action open it is visually easy to know for certain whether your shotgun is loaded or unloaded. Several easy steps will assure that you maintain a safe status when unloading your Supreme shotgun.

Before opening the action to unload make sure that the muzzle end of the barrels is in a safe direction and make sure that the safety is in the "on safe" position. Move it to the "off safe," fully rearward position, if it is not already there.

CAUTION: WHENEVER UNLOADING ALWAYS BE CERTAIN THAT THE MUZZLE IS POINTED IN A SAFE DIRECTION AND THAT THE SAFETY IS IN THE "ON SAFE" POSITION.

On the Supreme over and under the ejector/extractor mechanism mechanically adapts to whether there is a fired shell in a chamber or a loaded shell. With loaded shells the mechanism acts as an extractor, elevating the

shells in the chamber. With fired shells it acts as an ejector, forcefully ejecting the empty shell clear of the chamber and onto the ground.

1. To unload after firing, open the action by pushing and then locking the top lever fully to the right while you pull (or push) down on the barrels with your left hand. Depending on your stance, it may be very helpful to brace the buttstock between your right arm (at the elbow) and the side of your torso. (Tilt the angle of your gun slightly to the right, away from your body if you are right handed.) Push down until the barrels hinge downward fully and the rear of the chambers — and the bases of the shells — are fully exposed. You must tilt the chambers slightly to the right to have the empties eject to the right — well clear of your face (See Figure 17). Right-handed shooters tip to the right and left-handed shooters tip to the left.

BE CAREFUL: EMPTY SHELLS WILL EJECT OUT OF THE CHAMBERS RAPIDLY AND DIRECTLY IN LINE WITH THE CHAMBERS. IF YOU FAIL TO TIP THE CHAMBERS AWAY FROM YOUR FACE AND BODY THEY MAY STRIKE YOU IN THE FACE OR BODY, CAUSING INJURY.



FIGURE 17
Always tilt the chambers away from your face when opening the action.

Whenever possible be sure to pick up all of your empties after they are ejected so as to not to cause litter.

NOTE: With practice, it is possible to catch ejecting shells in your hand. If you open the action with the buttstock braced between your arm and torso, it is possible — when the action is almost fully opened — to remove the thumb of your right hand from the top lever and immediately cup your hand over the bases of the shells in the chambers. Continue to open the action, using your body and arm as leverage. As the action reaches the fully open

position the shells will eject and be stopped by your cupped hand. You can then simply remove them from the chambers and place them into your empty shell carrier.

2. Unfired shells will be elevated in the chambers by the extractors. They can be unloaded from your shotgun by simply pulling the unfired shell(s) out of the chambers with your fingers.

If only one barrel has been fired, only the empty shell will be ejected upon opening of the action. If you will be continuing to hunt or shoot, a loaded round can be inserted in its place. You are now fully loaded again.

MAKE SURE THE SAFETY IS IN THE "ON SAFE" POSITION AT ALL TIMES EXCEPT WHEN SHOOTING IS IMMINENT.

ALWAYS VISUALLY INSPECT THE CHAMBER VERY CAREFULLY AFTER UNLOADING TO BE SURE LIVE ROUNDS ARE CLEARED FROM THE GUN.

FIRING PROCEDURES

The Supreme will fire two shots — one with each with each pull of the trigger.

1. At all times except immediately preceding shooting, keep the safety in the rearward "on safe" position.

2. Load the chambers and close the action as explained under "Loading Procedures."

3. When shooting is imminent, and with a loaded shell in the chamber, the safety "on safe", and your finger off the trigger, push the safety to the "off safe" position (with the "S" fully covered by the safety switch). Your shotgun is now ready to fire with a pull of the trigger.

CAUTION: YOUR SHOTGUN IS NOW READY TO FIRE. REMEMBER, THE RECOIL FROM A SHOTGUN, ESPECIALLY MAGNUM LOADS, WILL BE SOMEWHAT HEAVIER THAN MOST OTHER GUNS, SO FIRMLY SHOULDER YOUR SUPREME, MOVE YOUR GUN TO ALIGN WITH THE TARGET AND — WHEN ON TARGET — SQUEEZE THE TRIGGER.

For training purposes or in some target situations your gun can be shot "single shot" by loading one shell at a time in only one of the chambers. For training new shooters, the bottom barrel is often used because of its slightly lower perceived recoil. Make sure the barrel selector is set for the barrel you will be firing.

If your gun fails to fire on the first pull of the trigger (because the selected barrel did not fire due to misfire, malfunction or simply because it was unloaded) the second barrel cannot be fired. Open the action and properly load the chambers before proceeding.

It is important to treat your gun as though it is loaded whenever the action is closed.

After you have completed firing you should either reload the chamber(s) with unfired shells (if hunting/shooting is going to continue) or fully unload your shotgun (if shooting is completed). Either way, always first place the safety in the "on safe" position.

WHEN FIRING IS COMPLETED OR WHEN SHOOTING IS NO LONGER IMMINENT, IMMEDIATELY RETURN THE SAFETY TO THE "ON SAFE" POSITION.

IMPORTANT: UNDER NO CIRCUMSTANCES SHOULD YOU MOVE ON OR CONTINUE TO HUNT WITH YOUR SAFETY IN THE FIRE POSITION.

IN THE CASE OF A MISFIRE

Only rarely will it cause factory ammunition experience a misfire. If this ever happens to you when shooting your Supreme, please follow these instructions carefully.

CAUTION: IN CASE OF MISFIRE, KEEP THE BARREL POINTED IN A SAFE DIRECTION, CAREFULLY OPEN THE ACTION WHILE AVOIDING DIRECT EXPOSURE TO THE BREACH BY YOURSELF AND OTHERS. REMOVE THE SHELL FROM THE CHAMBER, FULLY UNLOAD YOUR SHOTGUN, REMOVING THE OTHER SHELL.

Carefully inspect the shell removed from the chamber you intended to fire. If the primer is indented, the shell should be disposed of in a manner that would prevent accidental injury to you, others, or the environment. If there is no indentation, your gun may have malfunctioned. Make certain you are following all firing procedures correctly. If it fails to indent the firing pin again your shotgun has malfunctioned and should be serviced by a qualified gunsmith, or by a U.S. Repeating Arms Co. Authorized Repair Center (ARC).

INVECTOR® PLUS CHOKE TUBE SYSTEM

The Supreme is fitted with one of the most popular and universally accepted choke tube systems on the market: Invector-Plus. Your Supreme shotgun is specially designed for this system only. Your choke tubes may be marked "Win-Plus." There is no difference. This means:

- It has a back-bored barrel.
- It is threaded to accept Invector-Plus choke tubes only.

The Invector-Plus system allows you to configure your Supreme for the patterns and/or choke constrictions your hunt or target situation demands. The system gives you the most highly engineered choke tapers — designed to produce the best possible patterns for target and field situations. Plus, it is extremely easy to switch choke constrictions to match your shooting conditions. Invector-Plus

tubes are fully steel and lead shot compatible. Most Invector-Plus choke tubes fit flush with the muzzle when installed. A special choke tube wrench is provided to remove and tighten these tubes.

Invector-Plus (Win-Plus) choke tubes are NOT interchangeable with any other choke tubes on the market including chokes listed as "Standard Invector," or Winchester's current line of "WinChoke" choke tubes.

USE ONLY CHOKE TUBES MARKED INVECTOR PLUS IN YOUR SUPREME. USE ONLY THE APPROPRIATE GAUGE OF INVECTOR PLUS CHOKE TUBES AS MARKED ON YOUR SUPREME SHOTGUN.

Failure to follow these warnings may damage your gun and cause injury to yourself and others. A special "Plus" choke tube wrench is provided to remove and tighten Invector-Plus choke tubes.

DO NOT FIRE THIS SHOTGUN WITHOUT HAVING AN INVECTOR PLUS CHOKE TUBE INSTALLED. PERMANENT DAMAGE MAY RESULT TO THE THREADS.

CAUTION: WHENEVER HANDLING ANY SHOTGUN FOR THE PURPOSE OF REMOVING OR INSTALLING A CHOKING DEVICE, MAKE ABSOLUTELY CERTAIN THE

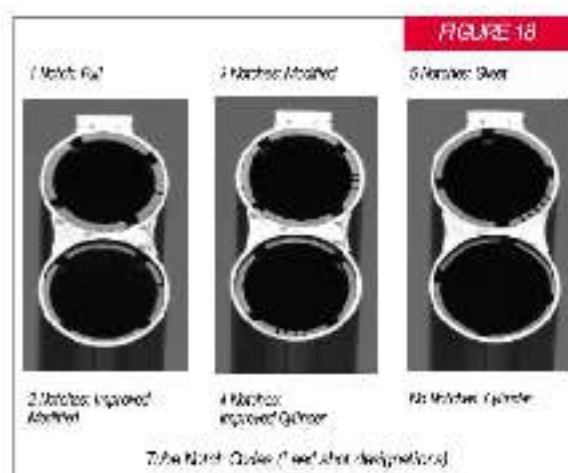

Small notches on the choke ends.
Large notches are for the choke tube wrench.

GUN IS FULLY UNLOADED, AND THE ACTION IS OPEN! NEVER ATTEMPT TO REMOVE OR INSTALL A SHOTGUN CHOKING DEVICE ON A LOADED RIFLE!

TUBE REMOVAL —

1. UNLOAD YOUR SUPREME SHOTGUN FULLY. INSPECT THE CHAMBERS TO MAKE SURE THEY DO

NOT CONTAIN ANY SHELLS.

2. Open the action fully downward, and place the "safety" in the "on safe" position.
3. Use the Invector Plus wrench to loosen the tube, turning it counterclockwise. Finger twist the tube the rest of the way out of the barrel.

TUBE INSTALLATION —

1. UNLOAD YOUR SUPREME SHOTGUN FULLY. INSPECT THE CHAMBERS TO MAKE SURE THEY DO NOT CONTAIN ANY SHELLS.

2. Open the action fully downward, and place the "safety" in the "on safe" position.
3. Before installing a tube, check the internal choke tube threads in the muzzle, as well as the threads on the Invector-Plus choke tube to be sure they are clean. Lightly oil the threads with a high quality light weight oil.
4. Using your fingers, screw the appropriate tube into the muzzle end of the barrel, tapered end first, notched end outward. When it becomes finger tight, use the Invector-Plus choke tube wrench to firmly seat the tube.

THE INVECTOR PLUS CHOKE TUBES SHOULD BE PERIODICALLY CHECKED TO ASSURE THAT THEY ARE TIGHT AND FIRMLY SEATED. BEFORE CHECKING, FOLLOW THE SAFETY GUIDELINES OUTLINED ABOVE.

SELECTING THE CORRECT INVECTOR-PLUS TUBE —

The Invector-Plus choke system is fully compatible with factory lead, tungsten, bismuth or steel shot loads. The conversion chart includes lead, tungsten, bismuth and steel shot information. Lead and steel shot perform differently in tubes with the same choke constrictions, for this reason, both lead and steel designations have proven necessary. In fact, even larger steel shot diameters result in different patterns than smaller steel shot sizes. Each designation is inscribed on each choke tube.

To help you choose the correct choke tube for each target shooting and hunting situation, all Invector-Plus choke tubes are inscribed on the side with abbreviations for the patterns they produce with both lead and steel shot.

Each tube also features identification notches located on the top rim of each tube (see Figure 18). These notches are a code to allow you to determine the choke designation while the tube is installed. Rim notches refer specifically to lead shot. You will need to use the chart below to cross-reference from lead to steel, and determine the appropriate tubes for your ammunition and hunting/shooting situation.

It is helpful to note that Bismuth shot responds similarly to lead shot and tungsten shot responds more like steel shot.

CHOKE TUBE RIM CODES AND PATTERNING —

Rim Notches	Pattern With Lead Shot	Pattern With Steel Shot
Extended**	X-Full Turkey	**
I	Full	*
II	Imp. Modified	Full†
III	Modified	Full†
III	Imp. Cylinder	Modified
III	Steel	Imp. Cylinder
No Notches	Cylinder	Cylinder

* Not for use with steel shot. Using an over-light choke or modified with steel shot will result in an ineffective "blow" pattern.

** Extra Full Special, extended with ports. Do not use with steel shot.

† When more than one choke designation is listed for a given steel shot pattern use the most open choke listed for high velocity, longer and steel shot loads.

CHANGING LENGTH OF PULL (SPECIAL MODELS)

Some Winchester Supreme shotguns are fitted with a special trigger shoe system that allows you to make small adjustments to the length of pull. This feature is usually found on target models where shooters benefit from highly customized settings.

It is easy to change the length of pull using the 1.5 mm allen (hex head) wrench included with your gun.

BEFORE PERFORMING THIS ADJUSTMENT, ALWAYS MAKE CERTAIN THERE ARE NO SHELLS IN THE CHAMBERS AND THE SAFETY IS IN THE "ON SAFE" POSITION.

1. Place your gun on its side on a secure, padded surface to prevent marring the finish.

2. Using the allen wrench provided (any good 5/64" hex wrench will work) loosen the trigger shoe from the trigger plate by inserting the wrench from the bottom into the set screw head (See Figure 19). Turn in a counterclockwise direction to loosen.

3. When the screw is sufficiently loose you will be able to move the trigger shoe along the trigger plate with your fingers. There are indexing dots on the trigger shoe and on the plate. Line up the dots to make length of pull longer or shorter as desired (See Figure 20).

4. Tighten the allen screw to secure the trigger shoe to the plate (turn in a clockwise direction to tighten). Make sure you have aligned the indexing dots in order to prevent marring the bottom of the trigger plate with the set screw.

5. With your gun unloaded, and pointed in a safe direction, shoulder your gun several times to see how the

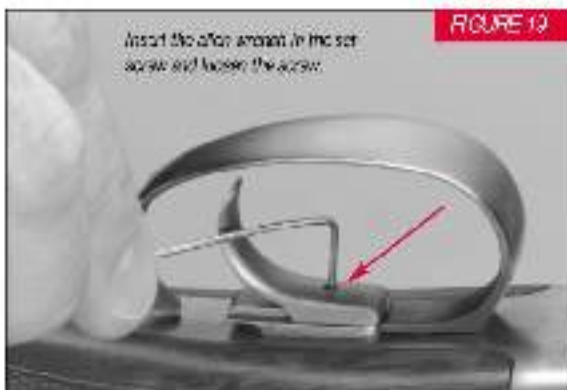

adjustment changes fit you. Increase or decrease the length of pull following the instructions above if necessary. Do not adjust more than allowed by the "dot" index marks on the plate and trigger shoe. When you have found the adjustment you prefer, tighten the set screw. Always make sure the trigger shoe is totally secure before firing. Checking the tightness of the set screw should be part of your regular maintenance.

CLEANING AND MAINTENANCE SUGGESTIONS

Your Supreme will function better and more reliably over a longer period of time if it is properly maintained and kept clean.



BEFORE PERFORMING ANY CLEANING PROCEDURES, ALWAYS MAKE CERTAIN THERE ARE NO SHELLS IN THE CHAMBERS.

You should clean your Supreme after every day of shooting and more often if it becomes excessively dirty.

A minimum cleaning includes wiping down the action and oiling key parts. Most regular maintenance will also include cleaning the barrels. If you encounter a function problem (tightness when breaking open or closing the action) be sure to give your gun a thorough cleaning to see if it solves the problem before seeking the services of our service facility or a competent gunsmith. To clean your firearm, adhere to the following general guidelines.

CLEANING PROCEDURES —

BE CERTAIN YOUR GUN'S CHAMBERS ARE UNLOADED. ALWAYS WEAR PROTECTIVE SAFETY GLASSES DURING ALL CLEANING PROCEDURES. KEEP AMMUNITION AWAY FROM THE CLEANING AREA. DO NOT TEST THE FUNCTION OF YOUR FIREARM WITH LIVE AMMUNITION.

ALWAYS PLACE THE SAFETY IN THE "ON SAFE" POSITION BEFORE BEGINNING ANY CLEANING PROCEDURE.

1. Use a cleaning rod with a tip and patch suitable for the size of your Supreme's bores. Make sure the patch is large enough for a snug fit in the bore. Insert the rod and patch into the barrel at the receiver end and run it back and forth several times.

2. Inspect the chamber and bore for lead and powder fouling. A normal amount of powder residue can be expected and is not serious. It can usually be removed by repeating step one, using a patch saturated with solvent. If or when fouling should become heavy, it can be removed with a brass bore brush. Dip or spray the brush with solvent and scrub the chamber and bore until the fouling is removed. To prevent brass bristles from breaking

off, the brush should be pushed completely through the bore before being withdrawn.

3. After fouling has been removed the bore should be wiped dry. Then pass a lightly oiled patch through the bore for preservation. A fine, light gun oil is recommended.

4. Wipe all exposed metal surfaces of the receiver, forearm and barrels with a clean rag. Finger marks should be removed because they provide a place where moisture can accumulate. Any dried oil in the receiver area should also be removed.

5. Lightly oil your gun at the points described under "Oiling the Action" explained earlier in this manual. Ordinary good judgment will, of course, indicate that the metal of the gun should receive a light film of oil any time the gun has been exposed to weather or handling. This is very important and must be done with every gun. Remember, the polished, finely fitted surfaces of the receiver and action mechanisms must always have a thin film of oil. Make sure that the surfaces of the locking pin system, and the hinge components are especially clean and lightly oiled with a high quality gun oil.

6. INSPECT THE BARRELS AND CHAMBERS. MAKE CERTAIN THAT NO PATCHES HAVE BEEN INADVERTENTLY LEFT IN THEM. REMOVE ANY THAT REMAIN.

7. Wipe all wood surfaces with a soft cloth.

8. When transporting only, store your S&W in a quality protective case to prevent scratches and dents. Store in a dry place to prevent corrosion. Steer away from children.

MAKE SURE YOUR SHOTGUN IS UNLOADED AND ALWAYS STORE AMMUNITION SEPARATELY.

DO NOT TAKE YOUR GUN'S ACTION APART BEYOND WHAT IS EXPLAINED IN THIS MANUAL.

This is a specialized, finely fitted mechanism; any attempt to disassemble the trigger group or bolt mechanism may mar its life. It is unnecessary, and may do damage to the inner mechanism, to disassemble these components for routine cleaning and oiling. Of course, misfortunes (such as dropping your gun in water) require appropriate attention, and in such circumstances we recommend you immediately take your gun to a competent gunsmith.

CLEANING THE INVECTOR-PLUS CHOKE SYSTEM —

1. Do not use a brass brush to clean your barrels unless choke tubes are installed in the barrels. Brushes could break off and lodge in the threads, making installation and removal difficult.

2. Regularly remove your gun's tubes in order to clean and oil the threads inside the barrel, as well as on the choke

tube itself. This will protect the threads from being damaged and also prevent a dirt build-up that would cause the choke tube to become difficult to remove from the barrel. Clean the threads with solvent and a small, soft brush like a toothbrush. Wipe completely clean and leave a thin film of clean oil on the threads: both on the tube and in the barrel. The threads of the choke tube and the internal threads of the barrel should be cleaned after each use and before the installation of a tube.

3. Be careful when removing/installing a tube. Use the specially designed wrench. Damage can result to both choke tube and barrel when attempting to remove sticky choke tubes.

4. Never fire your shotgun or run cleaning tools through the barrel of any choke-tubed gun without having the choke tubes installed.

OTHER CLEANING SUGGESTIONS —

- Never pour large quantities of oil into the receiver or other parts. It can drain down to the stock and soften it — and cause permanent damage and loosening of the stock.

- After extended periods of heavy use, your shotgun should be taken to a qualified gunsmith to have the action disassembled for professional cleaning and lubrication.

PARTS, SERVICE, REPAIR AND QUESTIONS

If your Winchester firearm should ever need repair or service, please utilize one of the world-wide network of U.S. Repeating Arms Company Authorized Repair Centers (ARC) for Winchester firearms. A list of ARCs is packaged with your new gun. *Never send your gun directly to our parts department or to our customer service facility in Morgan, Utah without direct authorization.* This will delay service significantly. It is much faster to have your gun serviced by a local ARC. If you have any questions about how to obtain service, or to locate the ARC nearest you, call us at: 1-800-945-5237.

If you have other questions (concerning general information, how to obtain parts, etc.), call or write our Customer Service Department. For questions about parts, you will be directed to the specific parts location for your Winchester firearm.

Customer Service
U. S. Repeating Arms Company, Inc.
275 Winchester Avenue
Morgan, Utah 84050-9333
Phone: 1-800-945-5237

CAUTION: PARTS ARE MADE FOR WINCHESTER BRAND GUNS MANUFACTURED BY OR FOR U.S. REPEATING ARMS COMPANY, INC., AND SHOULD NOT BE USED IN OTHER GUNS EVEN THOUGH MODELS MAY BE SIMILAR. IMPROPERLY FITTED PARTS MAY BE DANGEROUS.

WINCHESTER-GUNS.COM

U.S. Repeating Arms Company offers an information resource for you on the world wide web.

- List of authorized representatives.
- Customer service information.
- Answers to many technical and historical questions.
- Links to helpful sites.

Go to: www.winchester-guns.com

You Are Responsible For Firearms Safety.

As a gun owner, you accept a set of demanding responsibilities. How seriously you take these responsibilities can mean the difference between life and death. Failure to follow any of these instructions can cause extensive damage to your gun and/or possible serious injury or death to yourself and others. There is no excuse for careless or abusive handling of any firearm. At all times handle any firearm with intense respect for its power and potential danger. **READ AND UNDERSTAND all of THE CAUTIONS AND PROPER HANDLING PROCEDURES OUTLINED IN THIS BOOKLET BEFORE USING YOUR NEW FIREARM.**

1. ***ALWAYS KEEP THE MUZZLE OF ANY FIREARM POINTED IN A SAFE DIRECTION.***

Do this even though you are certain the firearm is unloaded. Never point any firearm at anything you do not intend to shoot. Be extremely alert and aware of all persons and property within the range of your ammunition.

2. ***NEVER RELY TOTALLY ON YOUR SHOTGUN'S MECHANICAL "SAFETY" DEVICE.***

Always assume that your gun can be fired at any time, even with all the safety mechanism engaged. The word "safety" describes a gun's trigger block mechanism, sear block mechanism, hammer block mechanism or firing pin block mechanism. These mechanical devices are designed to place your gun in a SAFER status. No guarantee can be made that the gun will not fire even if the "safety" is in the "on safe" position. See "Operation of the Safety" in your owner's manual for instructions on operation of your gun's "safety."

3. ***LIKE ANY MECHANICAL DEVICE, A "SAFETY" CAN SOMETIMES FAIL; IT CAN BE JARRED OR INADVERTENTLY MANIPULATED INTO AN UNSAFE CONDITION.***

Mechanical "safeties" merely aid safe gun handling and are no excuse for pointing your shotgun's muzzle in an unsafe direction.

While it is a good idea to "test" your shotgun's mechanical "safeties" periodically for proper function, never test them while your firearm is loaded or pointed in an unsafe direction. Safe gun handling does not stop with your gun's mechanical "safety" devices – it starts there.

Always treat this shotgun with the respect a loaded, ready-to-fire firearm. ***NEVER TEST THE MECHANISM OF ANY FIREARM WHILE IT IS LOADED OR POINTED IN AN UNSAFE DIRECTION.***

4. ***WHENEVER YOU HANDLE A FIREARM, OR HAND IT TO SOMEONE MAKE SURE IT IS COMPLETELY UNLOADED.***

Always open the action immediately and visually check the chamber magazine. Make certain the chamber does not inadvertently contain any ammunition. Always keep the chamber empty and the "safety" in the "on safe" position unless shooting is imminent.

5. ***DO NOT TRANSPORT ANY FIREARM LOADED. KEEP ALL FIREARMS UNLOADED DURING TRANSPORT, WHETHER IN A SCABBARD, GUN CASE, OR OTHER CONTAINER.***

6. ***HUNTING FROM ELEVATED SURFACES SUCH AS TREE STANDS IS DANGEROUS.***

Doing so may increase the risk of handling a firearm. The following rules should always be observed by you and those you hunt with: ***Always*** make certain that the stand being used is safe and stable. ***Always*** make certain that your firearm is unloaded when it is being taken up and down from the stand. ***Always*** make certain that your firearm is not dropped from the stand, or dropped while it is being taken up or down from the stand. ***Remember***, a loaded firearm may discharge when dropped, even with the safety in the "on safe" position.

7. **BEWARE OF BARREL OBSTRUCTION.**

Do this for the safety of both your gun and yourself. Mud, snow, and an infinite variety of other objects may inadvertently lodge in a barrel bore. It takes only one small obstruction to cause dangerously increased pressures that can ruin (swell, or rupture) the finest shotgun barrel. **BEFORE CHECKING FOR A BARREL OBSTRUCTION, BE CERTAIN YOUR FIREARM IS FULLY UNLOADED.**

Make sure no live rounds are in the chamber. Place the safety in the "on safe" position, open the breech or action and look through the barrel to be sure it is clear of any obstruction. If an obstruction is seen, no matter how small it may be, clean the bore with a cleaning rod and patch as instructed for your particular firearm. Before the first firing, clean the bore with a cleaning rod and patch, and wipe away any anti-rust compounds in the action/chamber areas.

8. **ALWAYS UNLOAD ALL FIREARMS WHEN NOT IN USE.**

As a safety precaution, it is preferable to disassemble your gun for storage. Your responsibilities do not end when your firearm is unattended. Store your gun and ammunition separately -- well beyond the reach of children. Take all safeguards to ensure your firearm does not become available to untrained, inexperienced or unwelcome hands.

9. **USE THE PROPER AMMUNITION.**

The barrel and action of all Browning firearms have been made with substantial safety margins over the pressures developed by established American commercial loads. Nevertheless, Browning assumes no liability for incidents which occur through the use of cartridges of nonstandard dimensions which develop pressures in excess of commercially available ammunition with standards established by the Sporting Arms and Ammunitions Manufacturers Institute (SAAMI).

BE ALERT TO THE SIGNS OF AMMUNITION MALFUNCTION.

If you detect an off sound or light recoil when ammunition is fired, **DO NOT LOAD MORE AMMUNITION INTO THE CHAMBER.** Open the action and remove all ammunition from the chamber. With the action open, glance down the barrel to make sure that a wad or other obstruction does not remain in the barrel. If there is an obstruction, completely clear the barrel before loading and firing again. Failure to follow these instructions can cause extensive damage to your gun and possible serious injury to yourself and others.

10. **MAKE SURE OF ADEQUATE VENTILATION IN THE AREA THAT YOU DISCHARGE A FIREARM. WASH HANDS THOROUGHLY AFTER EXPOSURE TO AMMUNITION OR CLEANING A FIREARM.**

Lead exposure can be obtained from discharging firearms in poorly ventilated areas, cleaning firearms or handling ammunition. Lead is a substance that has been known to cause birth defects, reproductive harm and other serious injury.

11. **NEVER INSERT A SHELL OF THE INCORRECT GAUGE IN ANY SHOTGUN.** The gauge of your shotgun is marked on the side of the barrel. Store all shells of different gauges in completely separate and well-marked containers. Never store shells of mixed gauges in a common container or in your pockets.

EXAMINE EVERY SHELL YOU PUT IN YOUR GUN. NEVER PUT A 20 GAUGE SHELL IN A 12 GAUGE GUN. The most common way to bulge or rupture a shotgun barrel is to drop a 20 gauge shell into a 12 gauge chamber. The 20 gauge shell, unfortunately, will not fall completely through the barrel; its rim is caught by the front of a 12 gauge chamber. Your gun will misfire (with the chamber appearing to be empty). It is then possible to load a 12 gauge shell behind the 20 gauge shell. If the 12 gauge shell is then fired, the result will be a so-called "12-20 burst" which can cause extensive damage to your gun and possible serious injury to you and others.

12. **USE SHELLS OF CORRECT LENGTH.**

The size of the chamber is inscribed, along with gauge and choke designations, on the side of the barrel. Do not use 3 1/2" shotgun shells in a shotgun or barrel with a 2 3/4" chamber or 3" chamber. Do not use 3" shells in a shotgun chambered for a 2 3/4" shells. Doing so can result in a build-up of dangerously high pressures that may damage your gun and possibly cause serious injury to yourself or others.

13. **DO NOT SNAP THE FIRING PIN ON AN EMPTY CHAMBER – THE CHAMBER MAY NOT BE EMPTY!**

Treat every gun with the respect due a loaded gun, even though you are certain the gun is unloaded.

14. **KEEP YOUR FINGERS AWAY FROM THE TRIGGER WHILE LOADING AND UNLOADING UNTIL YOU ARE READY TO SHOOT.**

15. **BE SURE OF YOUR TARGET AND BACKSTOP.** Particularly during low light periods. Know the range of your ammunition. Never shoot at water or hard objects.

16. **ALWAYS UNLOAD THE CHAMBER AND MAGAZINE OF ANY FIREARM BEFORE CROSSING A FENCE, CLIMBING A TREE, JUMPING A DITCH OR NEGOTIATING OTHER OBSTACLES.**

Never lean or place your loaded shotgun on or against a fence, tree, car or other similar object.

17. **WEAR EYE AND EAR PROTECTION WHEN SHOOTING.** Unprotected, repeated exposure to gunfire can cause hearing damage. Wear ear protectors (shooting earplugs or muffs) to guard against such damage. Wear shooting glasses to protect your eyes from flying particles. Always keep a safe distance between the muzzle of your firearm and any persons nearby, as muzzle blast, debris and ejecting shells could inflict serious injury. Also, wear eye protection when disassembling and cleaning all firearms to prevent the possibility of springs, spring-tensioned parts, solvents or other agents from contacting your eyes.

18. **DROPPING A LOADED GUN CAN CAUSE AN ACCIDENTAL DISCHARGE.**

This can occur even with the "safety" in the "on safe" position. Be extremely careful while hunting or during any shooting activity to avoid dropping any firearm.

19. **IF ANY FIREARM FAILS TO FIRE, KEEP THE MUZZLE POINTED IN A SAFE DIRECTION.**

Hold this position for a minimum of 30 seconds. Carefully open the action and remove the shell. If the primer is indented, the shell should be disposed of in a way that cannot cause harm. If the primer is not indented, your firearm should be examined by a qualified gunsmith and the cause of the malfunction should be corrected before further use.

20. **BE DEFENSIVE AND ON GUARD AGAINST UNSAFE GUN HANDLING AROUND YOU AND OTHERS.** Don't be timid when it comes to gun safety. If you observe other shooters violating any of these safety precautions, politely suggest safer handling practices.

21. **BE CERTAIN YOUR SHOTGUN IS UNLOADED BEFORE CLEANING.**

Because so many accidents occur when a firearm is being cleaned, special and extreme care should be taken to be sure your gun is unloaded before disassembly, cleaning and reassembly. Keep ammunition away from the cleaning location. Never test the mechanical function of any firearm with live ammunition.

22. SUPERVISE AND TEACH FIREARMS SAFETY TO ALL MEMBERS OF YOUR FAMILY – ESPECIALLY TO CHILDREN AND NONSHOOTERS.

Closely supervise newcomers to the shooting sports. Encourage enrollment in hunting/shooting safety courses.

23. NEVER DRINK ALCOHOLIC BEVERAGES OR TAKE ANY TYPE OF DRUGS BEFORE OR DURING SHOOTING.

Your vision and judgment could be dangerously impaired, making your gun handling unsafe to you and to others.

24. PERFORM PERIODIC MAINTENANCE – AVOID UNAUTHORIZED SERVICING.

Your firearm is a mechanical device which will not last forever, and as such, is subject to wear and requires periodic inspection, adjustment and service. Browning firearms should be serviced by a Browning Recommended Service Center or by Browning's service facility in Arnold, Missouri. Browning cannot assume any responsibility for injuries suffered or caused by unauthorized servicing, alterations or modifications of Browning firearms.

25. READ AND HEED ALL WARNINGS in these instructions, on ammunition boxes and with all accessories that you install on your firearm. It is your responsibility to secure the most up-to-date information on the safe handling procedures of your Browning gun. Browning assumes no liability for incidents which occur when unsafe or improper gun accessories or ammunition combinations are used.

26. Browning reserves the right to refuse service on firearms that have been altered, added to or substantially changed. Removal of metal from barrel(s), or modification of the firing mechanism and/or operating parts may lead to Browning's refusal of service on such firearms. Browning will charge the owner for parts and labor to return the firearm to original Browning specifications.

DO NOT, UNDER ANY CIRCUMSTANCES, ALTER THE TRIGGER, SAFETY OR OTHER PARTS OF THE FIRING MECHANISM OF THIS OR ANY OTHER FIREARM. FAILURE TO OBEY THIS WARNING MAY RESULT IN INJURY OR DEATH TO YOURSELF OR OTHERS.

BE CAREFUL!



WINCHESTER
RIFLES AND SHOTGUNS

U.S. Repeating Arms Company, Inc.
275 Winchester Avenue
Morgan, Utah, U. S. A. 84050-9333
www.winchester-guns.com

Winchester trademarks licensed from Q In Corporation.